

Gaber®

TABLES COLLECTION

Gaber®

Tables-Tavoli	Pag. 16
Low Tables-Tavoli Bassi	Pag. 26-28-30-34-36-39
High Tables-Tavoli Alti	Pag. 49-51-53-56-59
TKITT Collection	Pag. 74
Table Tops-Piani	Pag. 101
Table Bases-Basamenti Collection	Pag. 111
Stacking Table Bases-Basamenti accatastabili	Pag. 124
Indoor Table Bases-Basamenti per Interni	Pag. 146

CONTENTS / INDICE



ABSINTHE [N]
Studio Eurolinea
Design
P. 45



BANKET
Studio Eurolinea
Design
P. 51



BREAK
Studio Eurolinea
Design
P. 53



CHARME
Studio Eurolinea
Design
P. 17



CLARO [N]
Studio Eurolinea
Design
P. 39



FORMAT [N]
Studio Eurolinea
Design
P. 59



ICS
Studio Eurolinea
Design
P. 56



JACKIE
Studio Eurolinea
Design
P. 71



MUG [N]
Studio Eurolinea
Design
P. 63



NETTUNO
Studio Eurolinea
Design
P. 49



PROFILO [N]
Studio Eurolinea
Design
P. 43



QUINTINO
Studio Eurolinea
Design
P. 37



ROLLER
Studio Eurolinea
Design
P. 65



SATURNO
Studio Eurolinea
Design
P. 32



SATURNINO [N]
Studio Eurolinea
Design
P. 34



SIMPLY
Studio Eurolinea
Design
P. 61



SPACE
Studio Eurolinea
Design
P. 39



STEFANO
Studio Eurolinea
Design
P. 22



STEFANO 3-POD [N]
Studio Eurolinea
Design
P. 27



STEFANINO [N]
Studio Eurolinea
Design
P. 29



STEP
Studio Eurolinea
Design
P. 55



TESI [N]
Studio Eurolinea
Design
P. 47



TOGETHER
Marc Sadler
Design
P. 19



WOODY
Favaretto &
Partners Design
P. 31

CONTENTS / INDICE

TKITT COLLECTION



TKITT.BG3K
P. 77



TKITT.BG3L
P. 79



TKITT.BG4IP
P. 85



TKITT.BG4J
P. 82



TKITT.BG4K
P. 81



TKITT.BGA3L
P. 79



TKITT.BGA4K
P. 81



TKITT.BGPJ
P. 83



TKITT.BGPK
P. 82



TKITT.BPDT54
P. 91



TKITT.BQAJ
P. 95



TKITT.BQJ
P. 95



TKITT.BRK
P. 93



TKITT.BTAK
P. 87



TKITT.BTAK54
P. 89



TKITT.BTK
P. 87



TKITT.BTK54
P. 89



TKITT.STAKY
P. 97



TCONT.STADY
P. 99

TABLE TOPS



COMPACTOP
P. 102



IRON SURFACES
P. 104



LAMINATED SURFACES
P. 106



LEATHER SURFACES
P. 108



TECHNO POLYMER
P. 105

TABLE BASES COLLECTION



AMICA [N]
P. 145



BG2J
P. 127



BG3K
P. 113



BG3L
P. 117



BG4IP
P. 125



BG4J
P. 119



BG4K
P. 119



BGA3K
P. 113



BGA3L
P. 117



BGA4K
P. 121



BGPJ
P. 120



BGPK
P. 120



BPG3K
P. 115



BPG4K
P. 123



BQAJ
P. 141



BQJ
P. 141



BRCV
P. 133



BRK
P. 139



BTAK
P. 129



BTAK54
P. 131



BTK
P. 129



BTK54
P. 131



D2
P. 155



HALIFAX
P. 157



LEI [N]
P. 143



Q1
P. 151



Q2
P. 153



Q3
P. 153



R1
P. 147



R2
P. 147



R3
P. 148



T1 FLOOR
FIXING
P. 149



TATAMI [N]
P. 159



V1
P. 148



VENUS
ROUND
P. 135



VENUS
SQUARE
P. 137



COLOURS
COLORI
P. 162



THIS IS THE *RIGHT PLACE*

QUESTO È IL POSTO GIUSTO

The heart doesn't lie and, at first glance, it can recognize the right ambience in which people love finding each other to spend a moment of sincere friendliness. It is a complex and delicate alchemy composed with several ingredients, among which Gaber products have an important priority. Contributing to create this magic atmosphere is our specialty. We do it with competence, devotion and great passion, attempting to improve our products in every detail.

Il cuore non mente e sa riconoscere fin dal primo sguardo l'atmosfera giusta, quella che piace e dove la gente ama ritrovarsi per passare un momento di sincera convivialità. È un'alchimia complessa e delicata, composta da molti ingredienti, tra questi i prodotti Gaber che hanno un posto di prim'ordine. Contribuire a creare quest'atmosfera magica è nostro compito, la nostra specialità. Lo facciamo con professionalità, dedizione e grande passione, cercando continuamente di perfezionare i nostri prodotti in ogni particolare.

IT IS *OUR* SPECIALTY: COME WITH A DREAM, COME OUT WITH A *PROJECT*.

È LA *NOSTRA* SPECIALITÀ: ENTRI CON UN SOGNO, ESCI CON UN *PROGETTO*.



Traditional “Made In Italy” rules of design, and a constant view of the world of furniture, have led Gaber® to supply its products to prestigious contract projects. Expertise, innovative technology and customization serving the world of architecture and design: these are the main aspects of the Gaber® contract division. Years of experience in the design of plastic products, manufacturing moulds and tools, metalworking, moulding plastic products, have brought us today to meet the needs of a competitive international market, with due attention to quality and style. In the “contract” field we have established a target, allowing us to offer products that stand out in terms of design and quality, always with particular attention to details. Come with a dream, leave with a project.

Le radici nella tradizione del Made in Italy e lo sguardo proiettato sul mondo hanno portato Gaber® a fornire i propri prodotti per progetti di Contract prestigiosi. Competenza, tecnologie innovative e customizzazione al servizio del mondo dell'architettura e del design: questi i plus della divisione contract di Gaber®. Anni di esperienza nel settore della progettazione di manufatti plastici, nella realizzazione di stampi e attrezzature, nella lavorazione del metallo, nello stampaggio delle materie plastiche, ci hanno portato oggi a confrontarci con un mercato internazionale sempre più competitivo, attento alla qualità e allo stile. Nel settore “contract” abbiamo trovato una dimensione che ci permette di proporre prodotti che si distinguono come design e qualità formale, merito non solo della ricerca costante, ma anche di un livello tecnico superiore e di una particolare attenzione ai dettagli. Entri con un sogno, esci con un progetto.



AWARDS: SUCCESS IN PROGRESS

Gaber has won multiple design awards including honors from: Red Dot in Essen, Germany; Good Design Award of Chicago Athenaeum, USA; German Design Award, Germany; Interior Innovation Award from the German Design Council in Cologne, Germany; IF International Award from Forum Design of Munich, Germany; FX Award in London, UK; Young & Design in Milan, Italy; Top Ten during Promosedia Udine, Italy. These recognitions are a testament to Gaber's unstinting commitment to design and innovation.

MAGIC
2003
Studio
Eurolinea
Design



OVER
2004
Studio
Eurolinea
Design



PRISMA
2005
Studio
Eurolinea
Design



PRODIGE
2007
Delineo
Design



FLOWER
2008
Laura
Tombari



BIG BANG
2011
Stefano Sandonà
Sabrina Bettini



MOEMA wood
2011
Stefano
Sandonà



JOE
2011
Stefano
Sandonà



COLORFIVE
2011
Stefano
Sandonà



TOGETHER
2011
Marc Sadles



SLOT
chair and stool
2013
Favaretto &
Partners



CHEVALET
2013
Favaretto &
Partners



GOOD DESIGN AWARD 2014



BASKET CHAIR
2013
Alessandro
Busana



GOOD DESIGN AWARD 2014



EPICA
2014
Marc
Sadler



STILLY
2014
Studio
Eurolinea
Design



Gaber ha vinto diversi premi di design, tra cui gli onorevoli Red Dot in Essen-Germania, Good Design Award del Chicago Athenaeum–Usa, German Design Award–Germania, InteriorInnovation Award dal German Design Council in Colonia–Germania, IF International Award dal Forum Design di Monaco–Germany, FX Award di Londra–UK, Young & Design di Milano–Italy, Top Ten durante Promosedia Udine–Italy. I riconoscimenti sono una testimonianza del continuo impegno di Gaber per la progettazione, l'originalità e l'innovazione dei propri prodotti.

SPRING
2008
Monica
Graffeo



EXTREME
2009
Stefano
Sandonà



MOEMA
chair and stool
2009
Stefano
Sandonà



ALHAMBRA
2010
Stefano
Sandonà



FREEDOM
2010
Stefano
Sandonà



BLOG
chair and stool
2012
Stefano
Sandonà



OCTO
2012
Stefano
Sandonà



MORE
2012
Favaretto &
Partners



PANAMA
chair and stool
2013
Stefano
Sandonà



AKAMI
2013
Stefano
Sandonà



ISIDORO
2015
Favaretto &
Partners



ISIDORA
2015
Favaretto &
Partners



CHOPPY
2015
Favaretto &
Partners



Coverings and finishes stimulate and impact on the senses: they are decorations, textures and patterns. Research, technology and developments assist Gaber® in the production of new emotional tactile feelings on surfaces made for Interior Design. This is the *place* where your *articles* are born.

Rivestimenti e finiture superficiali suscitano emozioni e sollecitano i sensi: che si tratti di decori, texture o trame. Ricerca, sperimentazione e tecnologia aiutano Gaber® nella produzione di nuovi effetti tattili ed emozionali per le superfici destinate all'InteriorDesign. Questo è il *posto* dove nascono i vostri *prodotti*.





TABLES / TAVOLI



CHARME

Studio Eurolinea Design

Iron table top,
painted metal frame.

Tavolo con piano Iron e struttura
in metallo verniciato.

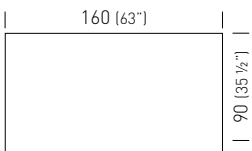
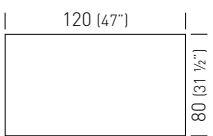
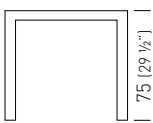

TCHAI400,___/H75  0.48m³ / 20kg / 1pcs

TCHAI402,___/H75  0.72m³ / 22kg / 1pcs

Colors / Colori

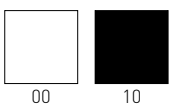



TOGETHER

Marc Sadler Design

Natural Oak wood table top
and polycarbonate legs:
transparent, solid white,
solid black.

Tavolo con piano in legno di
rovere, gambe in policarbonato
trasparente, bianche o nere.



Top Color / Colore Piano



Technopolymer Frame Color / Colore Struttura Tecnopolimero

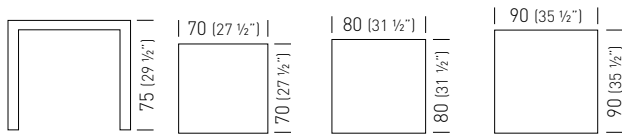
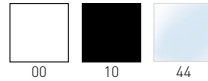

70x70
80x80
90x90

TTOGL420._._/H75
TTOGL422._._/H75
TTOGL424._._/H75

0.40m³ / 16kg / 1pcs
 0.40m³ / 18kg / 1pcs
 0.40m³ / 20kg / 1pcs



TOGETHER

Marc Sadler Design

Natural Oak wood table top
and frame.

Tavolo con piano e struttura
in legno di rovere.



Top Color / Colore Piano **Wooden Frame Color / Colore Struttura Legno**

RN RN

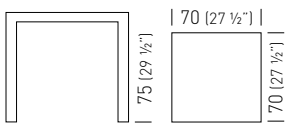

70x70	TTOGL420.___/H75		0.40m ³ / 16kg / 1pcs
80x80	TTOGL422.___/H75		0.40m ³ / 18kg / 1pcs
90x90	TTOGL424.___/H75		0.40m ³ / 20kg / 1pcs
120x80	TTOGL426.___/H75		0.48m ³ / 24kg / 1pcs
180x90	TTOGL428.___/H75		0.80m ³ / 33kg / 1pcs



Top Color / Colore Piano **Wooden Frame Color / Colore Struttura Legno**

RN RN

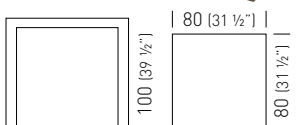

80x80	TTOGL422.___/H100		0.42m ³ / 22kg / 1pcs
90x90	TTOGL424.___/H100		0.42m ³ / 24kg / 1pcs
120x80	TTOGL426.___/H100		0.50m ³ / 27kg / 1pcs



Top Color / Colore Piano **Wooden Frame Color / Colore Struttura Legno**

RN RN

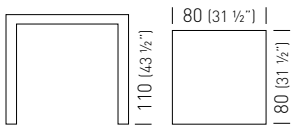

80x80	TTOGL422.___/H110		0.42m ³ / 22kg / 1pcs
90x90	TTOGL424.___/H110		0.42m ³ / 24kg / 1pcs
120x80	TTOGL426.___/H110		0.50m ³ / 27kg / 1pcs

STEFANO

Studio Eurolinea Design

Compactop table-top and beech legs.
Or with technopolymer legs, suitable
for outdoor use. Lightweight and
functional.

Tavolo con piano Compactop e gambe in
legno di faggio. Disponibile anche con
gambe in tecnopolimero, adatte all'uso
esterno. Leggero e funzionale.



Top Color / Colore Piano

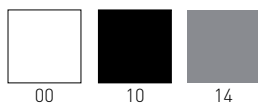

Wooden Frame Color / Colore Struttura Legno

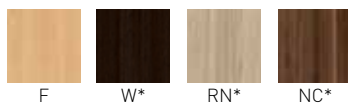

* on demand /
su richiesta

Fullcolor white top available on demand.
Bianco Fullcolor disponibile su richiesta.

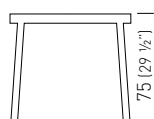

diam.80	TSTEC102.___/H75		0.4m ³ / 18kg / 1pcs
diam.100	TSTEC114.___/H75		0.58m ³ / 19kg / 1pcs
diam.120	TSTEC122.___/H75		0.71m ³ / 20kg / 1pcs
diam.140	TSTEC129.___/H75		0.87m ³ / 24kg / 1pcs



Top Color / Colore Piano

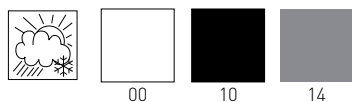

Technopolymer Frame Color / Colore Struttura Tecnopolimero

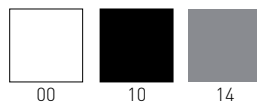

Fullcolor white top available on demand.
Bianco Fullcolor disponibile su richiesta.

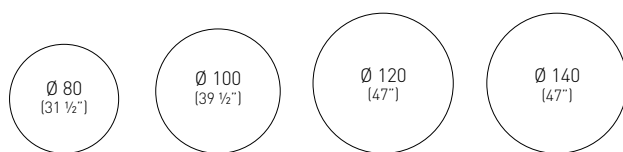
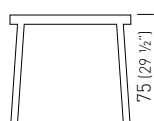

diam.80	TSTEC102.___/H75		0.4m ³ / 18kg / 1pcs
diam.100	TSTEC114.___/H75		0.58m ³ / 19kg / 1pcs
diam.120	TSTEC122.___/H75		0.71m ³ / 20kg / 1pcs
diam.140	TSTEC129.___/H75		0.87m ³ / 24kg / 1pcs





STEFANO

Studio Eurolinea Design

Compactop table-top and beech legs. Or with technopolymer legs, suitable for outdoor use. Lightweight and functional.

Tavolo con piano Compactop e gambe in legno di faggio. Disponibile anche con gambe in tecnopolimero, adatte all'uso esterno. Leggero e funzionale.



Top Color / Colore Piano

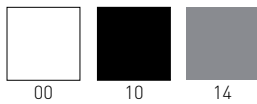

Fullcolor white top available on demand.
Bianco Fullcolor disponibile su richiesta.

Wooden Frame Color / Colore Struttura Legno

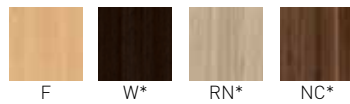

* on demand /
su richiesta

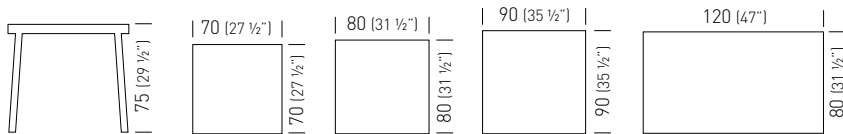

70x70	TSTEC098._._/H75		0.40m ³ / 17kg / 1pcs
80x80	TSTEC106._._/H75		0.40m ³ / 18kg / 1pcs
90x90	TSTEC110._._/H75		0.40m ³ / 18.5kg / 1pcs
120x80	TSTEC126._._/H75		0.52m ³ / 18.5kg / 1pcs



Top Color / Colore Piano

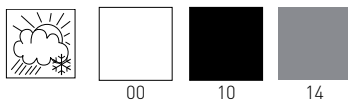

Fullcolor white top available on demand.
Bianco Fullcolor disponibile su richiesta.

Technopolymer Frame Color / Colore Struttura Tecnopolimero

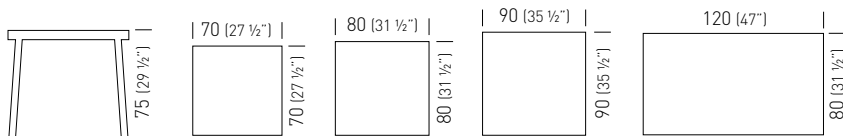
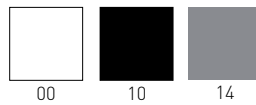

70x70	TSTEC098._._/H75		0.40m ³ / 17kg / 1pcs
80x80	TSTEC106._._/H75		0.40m ³ / 18kg / 1pcs
90x90	TSTEC110._._/H75		0.40m ³ / 18.5kg / 1pcs
120x80	TSTEC126._._/H75		0.52m ³ / 18.5kg / 1pcs



STEFANO 3-POD

Studio Eurolinea Design

Waiting areas
and Coffee Table, Compactop
with three beech legs.

Tavolino attesa
con piano Compactop
e tre gambe in legno di faggio.



Top Color / Colore Piano

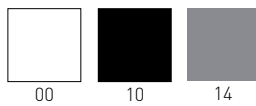

Fullcolor white top available on demand.
Bianco Fullcolor disponibile su richiesta.

Wooden Frame Color / Colore Struttura Legno



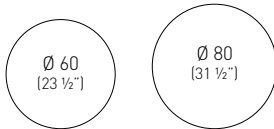
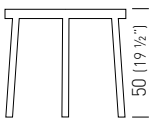

* on demand /
su richiesta



diam.60
diam.80

TSTEC090.___/3H50
TSTEC102.___/3H50

 0.30m³ / 17kg / 1pcs
 0.40m³ / 18kg / 1pcs



STEFANINO

Studio Eurolinea Design

Waiting areas
and Coffee Table,
Compactop with beech legs.

Tavolino attesa
con piano Compactop
e gambe in legno di faggio.



Top Color / Colore Piano

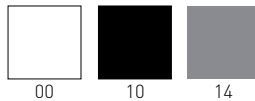

Fullcolor

Wooden Frame Color / Colore Struttura Legno



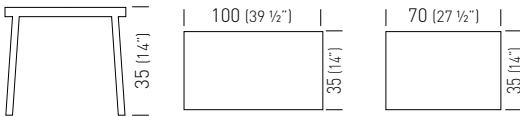

* on demand /
su richiesta



100x35
70x35

TSTEC118. __-__ /H35
TSTEC094. __-__ /H35

 0.34m³ / 10kg / 1pcs
 0.34m³ / 7kg / 1pcs



WOODY

Favaretto & Partners Design

Waiting areas and Coffee Table,
double Compactop wooden and
beech legs.

Tavolino attesa con doppio piano
Compactop e gambe in legno di
faggio.



Top Color / Colore Piano



00

Fullcolor

Wooden Frame Color / Colore Struttura Legno



F



W*



RN*



NC*

* on demand /
su richiesta

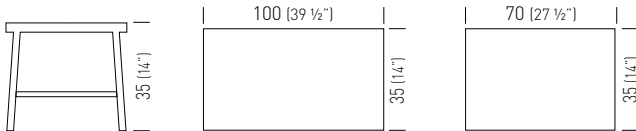

100x35
70x35

TW00C132.00-F./H35
TW00C130.00-F./H35



0.18m³ / 12kg / 1pcs



0.13m³ / 9kg / 1pcs

SATURNO

Studio Eurolinea Design

Compactop with painted aluminum frame.

Tavolo con piano Compactop e struttura in alluminio verniciato.



Top Color / Colore Piano



00



10



14

Fullcolor white top available on demand.
Bianco Fullcolor disponibile su richiesta.

Base Color / Colore Base



00

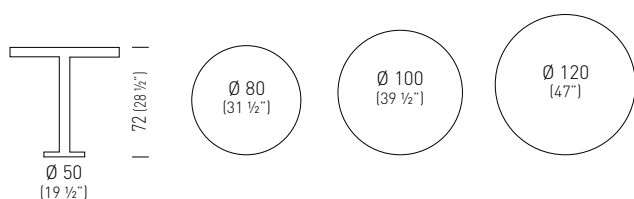

diam.80
diam.100
diam.120

TSATC142.___/H72
TSATC146.___/H72
TSATC150.___/H72

 0.56m³ / 28kg / 1pcs
 0.74m³ / 30kg / 1pcs
 0.87m³ / 33kg / 1pcs



SATURNINO

Studio Eurolinea Design

Waiting areas and Coffee Table,
Compactop with painted aluminum
frame.

Tavolino attesa con piano Compactop e
struttura in alluminio verniciato.



Top Color / Colore Piano

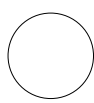

00
Fullcolor

Base Color / Colore Base

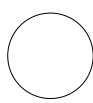

00

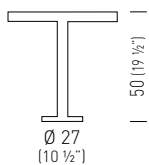

Ø 27
(10 1/2")

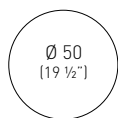

Ø 50
(19 1/2")

diam.50

TSATC140.__-/H50

 0.3m³ / 10kg / 1pcs





QUINTINO

Studio Eurolinea Design



Waiting areas table, leather table-top and painted metal frame.





Tavolino attesa con piano rivestito in pelle e struttura in metallo verniciato.

Top Color / Colore Piano

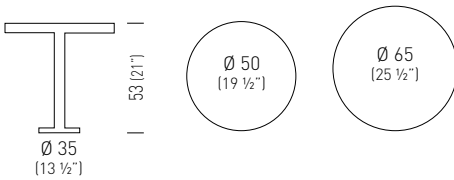
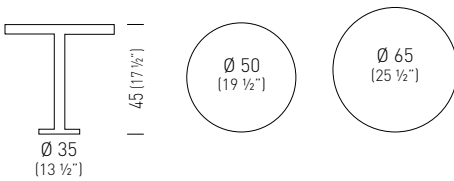

Base Color / Colore Base



diam.50	TQUIP160._._/H45		0.4m ³ / 17kg / 1pcs
diam.65	TQUIP162._._/H45		0.4m ³ / 17kg / 1pcs
diam.50	TQUIP160._._/H53		0.4m ³ / 18kg / 1pcs
diam.65	TQUIP162._._/H53		0.4m ³ / 18kg / 1pcs



CLARO

Studio Eurolinea Design



Table with co-injected metal frame with techno polymer, Compactop or laminated top. Suitable for outdoor purpose.

Tavolo con struttura in metallo sovrastampato con tecnopolimero, piano in Compactop o laminato. Adatto anche all'uso esterno.

Frame Color / Colore Struttura

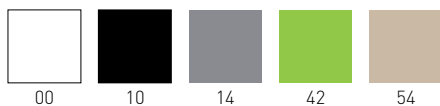

Compactop Color / Colore Piano Compactop

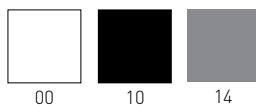

Laminated Top Color / Colore Piano Laminato



Fullcolor white top available on demand.
Bianco Fullcolor disponibile su richiesta.

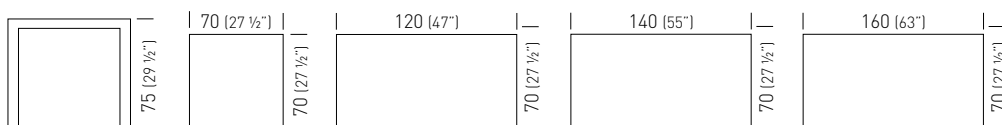

70x70compactop	TCLAC570.__-_/H75		0.24m ³ / 22kg / 1pcs
70x70laminated	TCLAL580.__-_/H75		0.24m ³ / 22kg / 1pcs
70x120compactop	TCLAC572.__-_/H75		0.36m ³ / 27kg / 1pcs
70x120laminated	TCLAL582.__-_/H75		0.36m ³ / 27kg / 1pcs
70x140compactop	TCLAC574.__-_/H75		0.41m ³ / 31kg / 1pcs
70x140laminated	TCLAL584.__-_/H75		0.41m ³ / 31kg / 1pcs
70x160compactop	TCLAC576.__-_/H75		0.46m ³ / 35kg / 1pcs
70x160laminated	TCLAL586.__-_/H75		0.46m ³ / 35kg / 1pcs



SPACE

Studio Eurolinea Design

Compactop with anodized aluminum frame.

Tavolo con piano Compactop e struttura in alluminio anodizzato.



Top Color / Colore Piano



Fullcolor white top available on demand.
Bianco Fullcolor disponibile su richiesta.

Frame Color / Colore Struttura



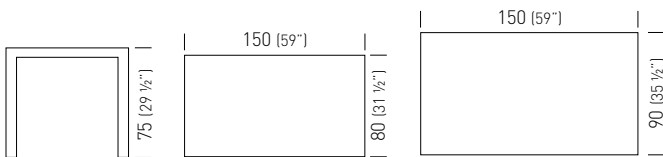

Anodized aluminum
Alluminio anodizzato



80x150
90x150

TSPAC414._-/H75
TSPAC416._-/H75

 0.68m³ / 28kg / 1pcs
 0.68m³ / 30kg / 1pcs



Top Color / Colore Piano



Fullcolor white top available on demand.
Bianco Fullcolor disponibile su richiesta.

Frame Color / Colore Struttura



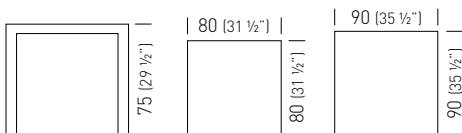

Anodized aluminum
Alluminio anodizzato



80x80
90x90

TSPAC410._-/H75
TSPAC412._-/H75

 0.36m³ / 19kg / 1pcs
 0.36m³ / 21kg / 1pcs



PROFILO

Studio Eurolinea Design



Compactop or Laminated table top with painted metal frame. Adjustable feet.

Tavolo con struttura in metallo verniciato, piano in Compactop o Laminato. Piedini regolabili

Frame Color / Colore Struttura

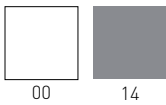

Compactop Color / Colore Piano Compactop

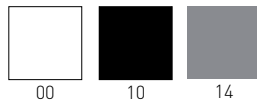

Laminated Top Color / Colore Piano Laminato



Fullcolor white top available on demand.
Bianco Fullcolor disponibile su richiesta.

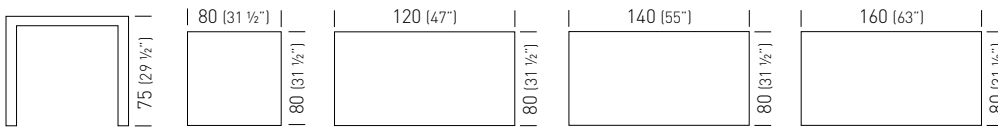

80x80compactop	TPROC500. __-__ /H75		0.32m ³ / 24kg / 1pcs
80x80laminated	TPROL518. __-__ /H75		0.32m ³ / 24kg / 1pcs
80x120compactop	TPROC502. __-__ /H75		0.43m ³ / 29kg / 1pcs
80x120laminated	TPROL520. __-__ /H75		0.43m ³ / 29kg / 1pcs
80x140compactop	TPROC504. __-__ /H75		0.48m ³ / 33kg / 1pcs
80x140laminated	TPROL522. __-__ /H75		0.48m ³ / 33kg / 1pcs
80x160compactop	TPROC506. __-__ /H75		0.53m ³ / 38kg / 1pcs
80x160laminated	TPROL524. __-__ /H75		0.53m ³ / 38kg / 1pcs



ABSINTHE

Studio Eurolinea Design



Compactop or Laminated table top with painted metal frame. Adjustable feet.

Tavolo con struttura in metallo verniciato, piano in Compactop o Laminato. Piedini regolabili

Frame Color / Colore Struttura

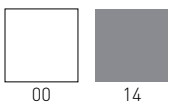

Compactop Color / Colore Piano Compactop

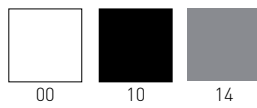

Laminated Top Color / Colore Piano Laminato



Fullcolor white top available on demand.
Bianco Fullcolor disponibile su richiesta.

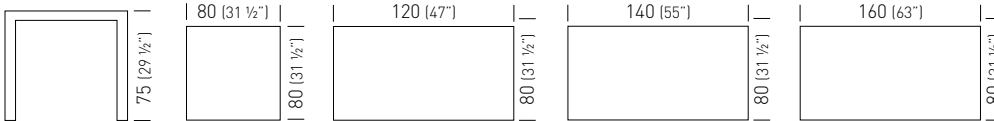

80x80compactop	TABSC470.___/_/H75		0.24m ³ / 22kg / 1pcs
80x80laminated	TABSL484.___/_/H75		0.24m ³ / 22kg / 1pcs
80x120compactop	TABSC472.___/_/H75		0.36m ³ / 27kg / 1pcs
80x120laminated	TABSL486.___/_/H75		0.36m ³ / 27kg / 1pcs
80x140compactop	TABSC474.___/_/H75		0.41m ³ / 31kg / 1pcs
80x140laminated	TABSL488.___/_/H75		0.41m ³ / 31kg / 1pcs
80x160compactop	TABSC476.___/_/H75		0.46m ³ / 35kg / 1pcs
80x160laminated	TABSL490.___/_/H75		0.46m ³ / 35kg / 1pcs



TESI

Studio Eurolinea Design



Compactop or Laminated table top with painted metal frame. Adjustable feet.

Tavolo con struttura in metallo verniciato, piano in Compactop o Laminato. Piedini regolabili

Frame Color / Colore Struttura

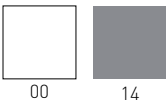

Compactop Color / Colore Piano Compactop

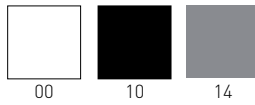

Fullcolor white top available on demand.
Bianco Fullcolor disponibile su richiesta.

Laminated Top Color / Colore Piano Laminato

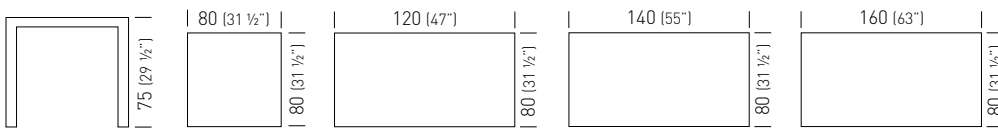
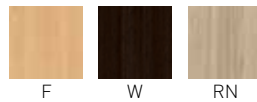
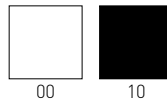

80x80compactop	TTESC540.___/_/H75		0.32m ³ / 24kg / 1pcs
80x80laminated	TTESL558.___/_/H75		0.32m ³ / 24kg / 1pcs
80x120compactop	TTESC542.___/_/H75		0.43m ³ / 29kg / 1pcs
80x120laminated	TTESL560.___/_/H75		0.43m ³ / 29kg / 1pcs
80x140compactop	TTESC544.___/_/H75		0.48m ³ / 33kg / 1pcs
80x140laminated	TTESL562.___/_/H75		0.48m ³ / 33kg / 1pcs
80x160compactop	TTESC546.___/_/H75		0.53m ³ / 38kg / 1pcs
80x160laminated	TTESL564.___/_/H75		0.53m ³ / 38kg / 1pcs



NETTUNO

Studio Eurolinea Design

Laminated table top and painted metal frame.

Tavolo con piano laminato e struttura fissa o estensibile in metallo verniciato.



Laminated Top Color / Colore Piano Laminato



Frame Color / Colore Struttura

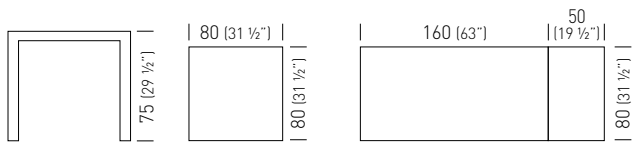
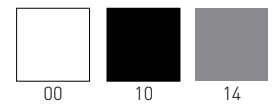

80x80 TNETL450._._/H75 0.44m³ / 15kg / 1pcs
 80x160-210 TNETL452._._/H75 0.64m³ / 20kg / 1pcs



Laminated Top Color / Colore Piano Laminato



Frame Color / Colore Struttura

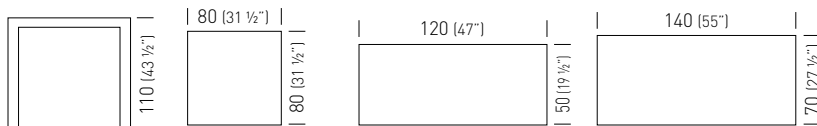
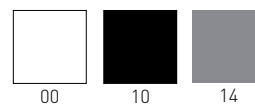

80x80 TNETL450._._/H110 0.64m³ / 18kg / 1pcs
 50x120 TNETL454._._/H110 0.60m³ / 24kg / 1pcs
 70x140 TNETL456._._/H110 0.65m³ / 26kg / 1pcs

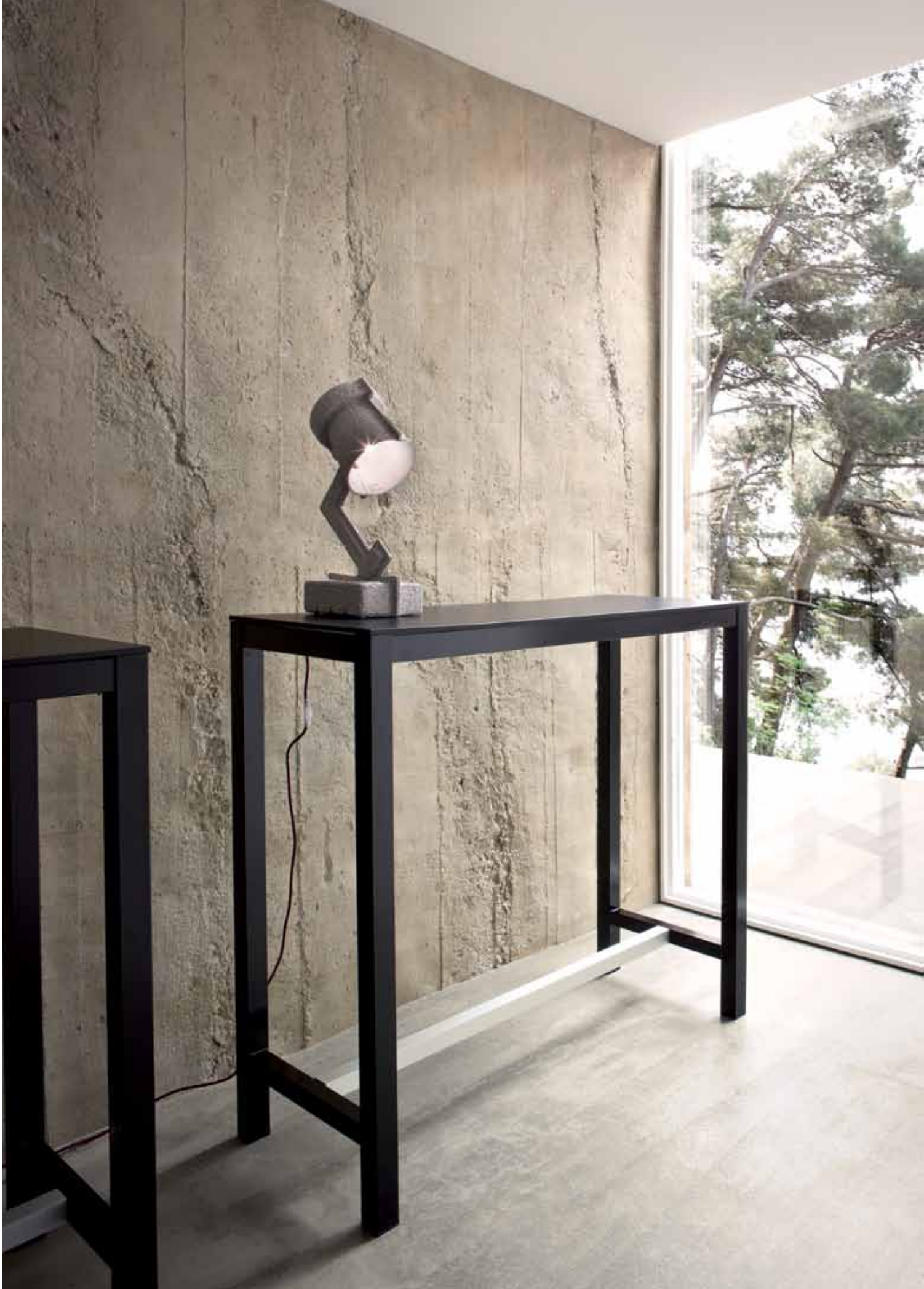

BANKET

Studio Eurolinea Design

High table, Compactop or
Laminated table top, painted
metal frame.

Tavolo alto con struttura in
metallo verniciato, piano in
Compactop o Laminato.



Frame Color / Colore Struttura

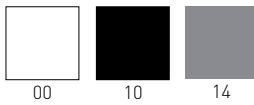

Compactop Color / Colore Piano Compactop

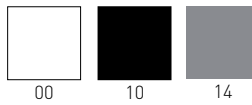

Laminated Top Color / Colore Piano Laminato



Only with Compactop
Solo con Compactop

Fullcolor white top available on demand.
Bianco Fullcolor disponibile su richiesta.

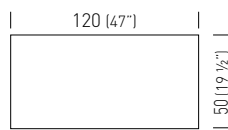
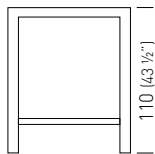

120x50compactop
120x50laminated

TBNKC800._._/H110
TBNKL804._._/H110



0.47m³ / 18kg / 1pcs
0.47m³ / 18kg / 1pcs



BREAK

Studio Eurolinea Design

High table, Laminated surfaces,
chromed footrest.

Tavolo alto con struttura in
Laminato e poggiatesta cromato.

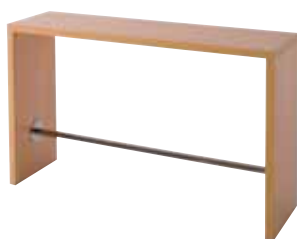

Laminated Top Color / Colore Piano Laminato

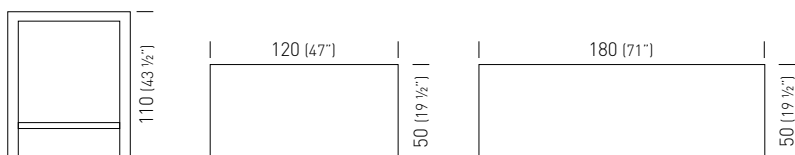

120x50	TBRKL810. __-__ /H110		0.52m ³ / 25kg / 1pcs
180x50	TBRKL814. __-__ /H110		0.76m ³ / 30kg / 1pcs



STEP

Studio Eurolinea Design

High table, co-injected metal frame with techno polymer, Compactop. Suitable for outdoor purpose.

Tavolo alto con struttura in metallo sovrastampato con tecnopolimero, piano in Compactop. Adatto anche all'uso esterno.



Compactop Color / Colore Piano Compactop

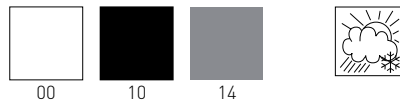

Fullcolor white top available on demand. Bianco Fullcolor disponibile su richiesta.

Technopolymer Frame Color / Colore Struttura Tecnopolimero

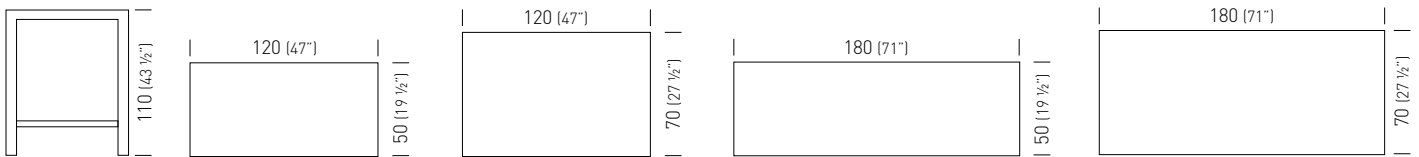
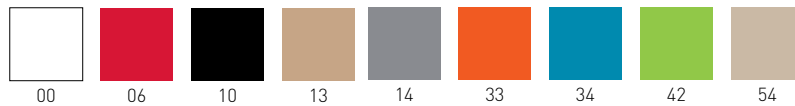

120x50	TSTPC820. __ - __ / H110	0.47m³ / 25kg / 1pcs
120x70	TSTPC822. __ - __ / H110	0.48m³ / 26kg / 1pcs
180x50	TSTPC824. __ - __ / H110	0.60m³ / 27kg / 1pcs
180x70	TSTPC826. __ - __ / H110	0.60m³ / 28kg / 1pcs



ICS

Studio Eurolinea Design

High table, painted metal frame,
Compactop or Laminated table top.
Adjustable feet.

Tavolo alto con struttura in metallo
verniciato, piano in Compactop o
Laminato. Piedini regolabili.

Frame Color / Colore Struttura



00



10

Compactop Color / Colore Piano Compactop



00



10



14

Laminated Top Color / Colore Piano Laminato



00



10



F



W



RN

Fullcolor white top available on demand.
Bianco Fullcolor disponibile su richiesta.

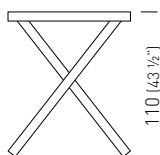

110 (43 1/2")

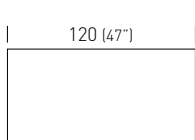

120 (47")

50 (19 1/2")

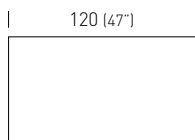

120 (47")

70 (27 1/2")

120x50compactop
120x50laminated
120x70compactop
120x70laminated

TICSC830._._/H110
TICSL836._._/H110
TICSC832._._/H110
TICSL838._._/H110



0.47m³ / 25kg / 1pcs
0.47m³ / 25kg / 1pcs
0.48m³ / 26kg / 1pcs
0.48m³ / 26kg / 1pcs





FORMAT

Studio Eurolinea Design

Table with metal painted frame
and Compact table top.
Suitable for outdoor purpose.
Adjustable feet.

Tavolo alto con struttura in metallo
sovrastampato con tecnopolimero,
piano in Compact.
Adatto anche all'uso esterno.
Piedini regolabili.

Compact Color / Colore Piano Compact

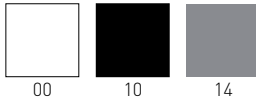

Frame Color / Colore Struttura

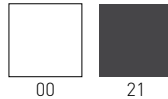

Fullcolor white top available on demand.
Bianco Fullcolor disponibile su richiesta.

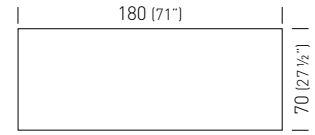
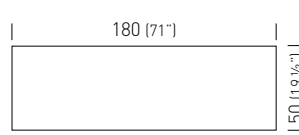
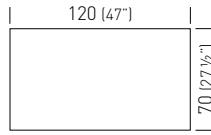
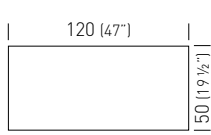
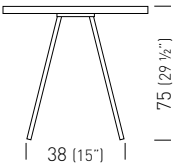

120x50
120x70
180x50
180x70

TFORC840._._/H75
TFORC842._._/H75
TFORC844._._/H75
TFORC846._._/H75

0.47m³ / 23kg / 1pcs
 0.48m³ / 24kg / 1pcs
 0.60m³ / 25kg / 1pcs
 0.60m³ / 26kg / 1pcs

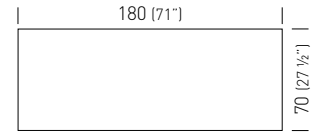
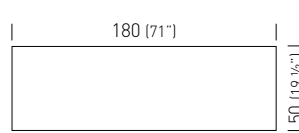
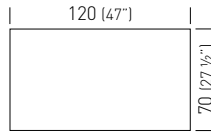
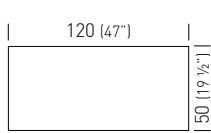
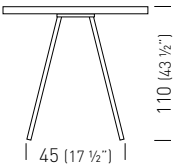

120x50
120x70
180x50
180x70

TFORC840._._/H110
TFORC842._._/H110
TFORC844._._/H110
TFORC846._._/H110

0.47m³ / 25kg / 1pcs
 0.48m³ / 26kg / 1pcs
 0.60m³ / 27kg / 1pcs
 0.60m³ / 28kg / 1pcs



SIMPLY

Studio Eurolinea Design

Stackable metal frame
and Iron table top,
suitable for outdoor use.

Tavolo impilabile con struttura in
metallo verniciato e piano Iron,
adatto all'uso esterno.

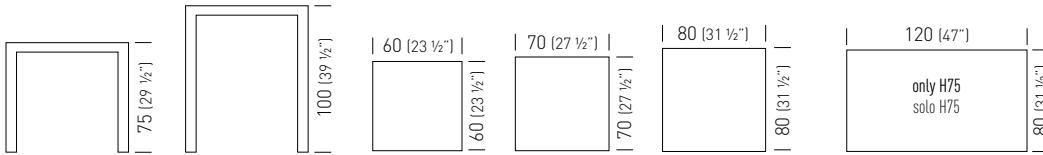
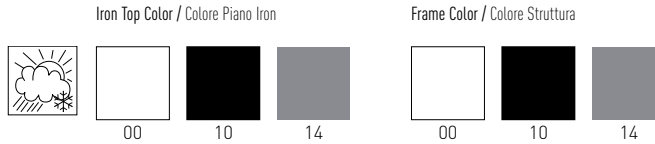

60x60	TSIMI430._._/H75		0.28m ³ / 17.5kg / 1pcs
60x60	TSIMI430._._/H100		0.28m ³ / 18.5kg / 1pcs
70x70	TSIMI432._._/H75		0.28m ³ / 18.5kg / 1pcs
70x70	TSIMI432._._/H100		0.28m ³ / 19.5kg / 1pcs
80x80	TSIMI434._._/H75		0.40m ³ / 19.5kg / 1pcs
80x80	TSIMI434._._/H100		0.40m ³ / 20.5kg / 1pcs
120x80	TSIMI436._._/H75		0.40m ³ / 25.0kg / 1pcs

Stackable table
with laminated top
and painted metal frame.

Tavolo impilabile con piano in
laminato spessore 22mm e telaio
in metallo verniciato.

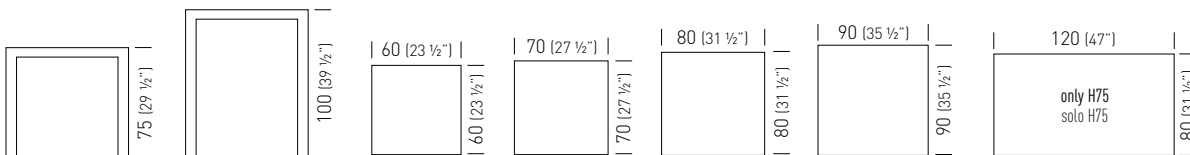
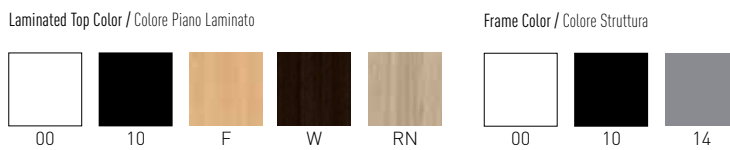

60x60	TSIML438._._/H75		0.28m ³ / 16kg / 1pcs
60x60	TSIML438._._/H100		0.28m ³ / 17kg / 1pcs
70x70	TSIML440._._/H75		0.28m ³ / 17kg / 1pcs
70x70	TSIML440._._/H100		0.28m ³ / 18kg / 1pcs
80x80	TSIML442._._/H75		0.40m ³ / 18.5kg / 1pcs
80x80	TSIML442._._/H100		0.40m ³ / 19.5kg / 1pcs
90x90	TSIML444._._/H75		0.40m ³ / 21kg / 1pcs
90x90	TSIML444._._/H100		0.40m ³ / 22kg / 1pcs
120x80	TSIML446._._/H75		0.40m ³ / 23.5kg / 1pcs



MUG

Studio Eurolinea Design



230V – 50Hz
1 X 16W – Led Modul
IP 65



H75 Table with Compactop, Technopolymer base. Available illuminated and suitable for outdoor use.

Tavolo realizzato con piano in Compactop H75 e struttura in tecnopolimero. Disponibile con versione luminosa e adatti all'uso esterno.

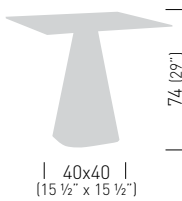

Compactop Color / Colore Piano Compactop



Fullcolor white top available on demand.
Bianco Fullcolor disponibile su richiesta.

Technopolymer Base Color / Colore Base Tecnopolimero



base74	BMUG.__/H74		0.13m ³ / 12.5kg / 1pcs
base74+20	BMUG.__/H74+20		0.13m ³ / 32.5kg / 1pcs
base74 Led	BMUG.__/H74L		0.13m ³ / 14.7kg / 1pcs



diam.60	TMUGC170.___/H74		0.21m ³ / 18.0kg / 1pcs
diam.60 Led	TMUGC170.___/H74L		0.21m ³ / 20.2kg / 1pcs
diam.60	TMUGC170.___/H74+20		0.21m ³ / 38.0kg / 1pcs



diam.68	TMUGC178.___/H74		0.23m ³ / 21.5kg / 1pcs
diam.68 Led	TMUGC178.___/H74L		0.23m ³ / 23.7kg / 1pcs
diam.68	TMUGC178.___/H74+20		0.23m ³ / 41.5kg / 1pcs



diam.80	TMUGC186.___/H74		0.5m ³ / 23.5kg / 1pcs
diam.80 Led	TMUGC186.___/H74L		0.5m ³ / 25.7kg / 1pcs
diam.80	TMUGC186.___/H74+20		0.5m ³ / 43.5kg / 1pcs



diam.100	TMUGC198.___/H74		0.67m ³ / 28.0kg / 1pcs
diam.100 Led	TMUGC198.___/H74L		0.67m ³ / 32.2kg / 1pcs
diam.100	TMUGC198.___/H74+20		0.67m ³ / 48.0kg / 1pcs

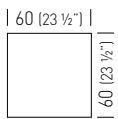

60x60	TMUGC174.___/H74		0.21m ³ / 20.0kg / 1pcs
60x60 Led	TMUGC174.___/H74L		0.21m ³ / 22.5kg / 1pcs
60x60	TMUGC174.___/H74+20		0.21m ³ / 39.5kg / 1pcs

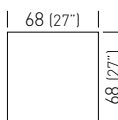

68x68	TMUGC182.___/H74		0.23m ³ / 21.8kg / 1pcs
68x68 Led	TMUGC182.___/H74L		0.23m ³ / 24.0kg / 1pcs
68x68	TMUGC182.___/H74+20		0.23m ³ / 41.8kg / 1pcs

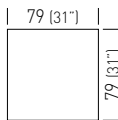

79x79	TMUGC190.___/H74		0.50m ³ / 25.0kg / 1pcs
79x79 Led	TMUGC190.___/H74L		0.50m ³ / 27.0kg / 1pcs
79x79	TMUGC190.___/H74+20		0.50m ³ / 45.0kg / 1pcs

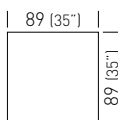

89x89	TMUGC194.___/H74		0.60m ³ / 26.0kg / 1pcs
89x89 Led	TMUGC194.___/H74L		0.60m ³ / 28.0kg / 1pcs
89x89	TMUGC194.___/H74+20		0.60m ³ / 46.0kg / 1pcs



ROLLER

Studio Eurolinea Design

Tables, chairs, benches and stools Collection. Compactop with technopolymer bases. Available illuminated and suitable for outdoor use.

Collezione di tavoli, sedute, panche e sgabelli. I tavoli sono realizzati con piano Compactop e struttura in tecnopolimero. Disponibili con versione luminosa e adatti anche all'uso esterno.



Technopolymer Base Color / Colore Base Tecnopolimero

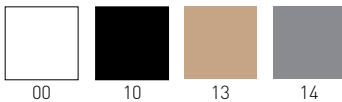

tavolino

244.--/A

0.1m³ / 4kg / 1pcs



Compactop Color / Colore Piano Compactop

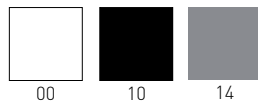

Technopolymer Base Color / Colore Base Tecnopolimero

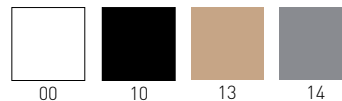

Fullcolor white top available on demand.
Bianco Fullcolor disponibile su richiesta.

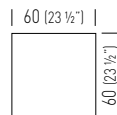
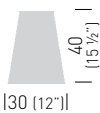

base
diam.60
60x60

BROLLER.___/H40
TROLCO40.___/H40
TROLCO44.___/H40

0.11m³ / 2,5kg / 1pcs
 0.18m³ / 8kg / 1pcs
 0.18m³ / 11,8kg / 1pcs



ROLLER

Studio Eurolinea Design

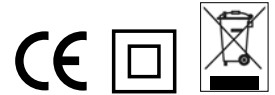

230V – 50Hz
1 X 16W – Led Modul
IP 65

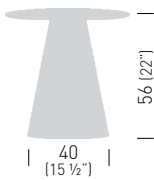

Compact Color / Colore Piano Compactop

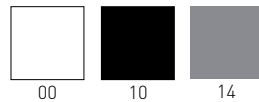

Fullcolor white top available on demand.
Bianco Fullcolor disponibile su richiesta.

Technopolymer Base Color / Colore Base Tecnopolimero

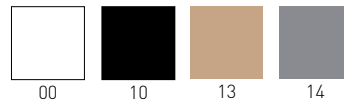

	base55	BROLLER.__/H55	0.13m ³ / 9.8kg / 1pcs
	base55 Led	BROLLER.__/H55L	0.13m ³ / 13kg / 1pcs
Ø 60 (23 1/2'')	diam.60	TROLC040.__-_/H55	0.21m ³ / 15.5kg / 1pcs
	diam.60	TROLC040.__-_/H55L	0.21m ³ / 18.8kg / 1pcs
Ø 68 (27'')	diam.68	TROLC048.__-_/H55	0.23m ³ / 19kg / 1pcs
	diam.68	TROLC048.__-_/H55L	0.23m ³ / 22.2kg / 1pcs
60 (23 1/2'')	60x60	TROLC044.__-_/H55	0.21m ³ / 17.5kg / 1pcs
	60x60	TROLC044.__-_/H55L	0.21m ³ / 20.7kg / 1pcs
68 (27'')	68x68	TROLC052.__-_/H55	0.23m ³ / 20.5kg / 1pcs
	68x68	TROLC052.__-_/H55L	0.23m ³ / 23.7kg / 1pcs

ROLLER

Studio Eurolinea Design



230V – 50Hz
1 X 16W – Led Modul
IP 65

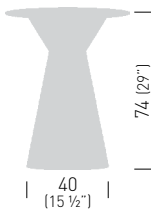

Compactop Color / Colore Piano Compactop

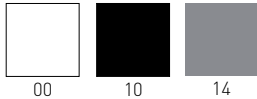

Technopolymer Base Color / Colore Base Tecnopolimero

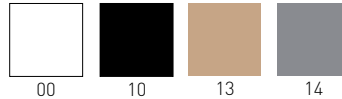

Fullcolor white top available on demand.
Bianco Fullcolor disponibile su richiesta.

base74	BROLLER.__/H74		0.13m ³ / 11.30kg / 1pcs
base74+20	BROLLER.__/H74+20		0.13m ³ / 31.30kg / 1pcs
base74 Led	BROLLER.__/H74L		0.13m ³ / 14.45kg / 1pcs



diam.60	TROLC040.__-_/H74		0.21m ³ / 16.8kg / 1pcs
diam.60	TROLC040.__-_/H74L		0.21m ³ / 19.9kg / 1pcs



diam.68	TROLC048.__-_/H74		0.23m ³ / 20.3kg / 1pcs
diam.68	TROLC048.__-_/H74L		0.23m ³ / 23.4kg / 1pcs



diam.80	TROLC056.__-_/H74		0.5m ³ / 22.3kg / 1pcs
diam.80	TROLC056.__-_/H74L		0.5m ³ / 25.5kg / 1pcs

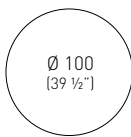

diam.100	TROLC068.__-_/H74		0.67m ³ / 27kg / 1pcs
diam.100	TROLC068.__-_/H74L		0.67m ³ / 30kg / 1pcs

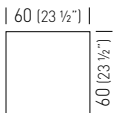

60x60	TROLC044.__-_/H74		0.21m ³ / 19.5kg / 1pcs
60x60	TROLC044.__-_/H74L		0.21m ³ / 22.5kg / 1pcs

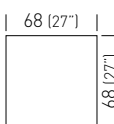

68x68	TROLC052.__-_/H74		0.23m ³ / 21.8kg / 1pcs
68x68	TROLC052.__-_/H74L		0.23m ³ / 25kg / 1pcs

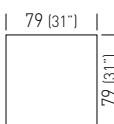

79x79	TROLC060.__-_/H74		0.5m ³ / 23.8kg / 1pcs
79x79	TROLC060.__-_/H74L		0.5m ³ / 27kg / 1pcs

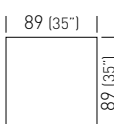

89x89	TROLC064.__-_/H74		0.6m ³ / 24.8kg / 1pcs
89x89	TROLC064.__-_/H74L		0.6m ³ / 27.9kg / 1pcs

ROLLER

Studio Eurolinea Design

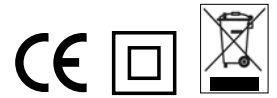
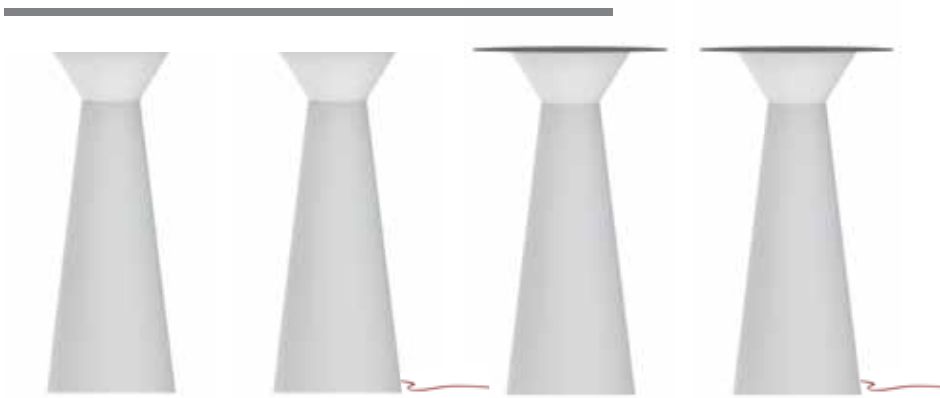

230V – 50Hz
1 X 16W – Led Modul
IP 65

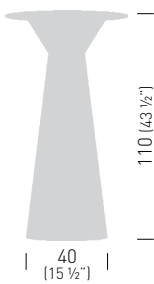

Compactop Color / Colore Piano Compactop

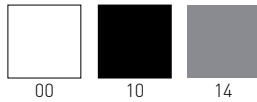

Fullcolor white top available on demand.
Bianco Fullcolor disponibile su richiesta.

Technopolymer Base Color / Colore Base Tecnopolimero

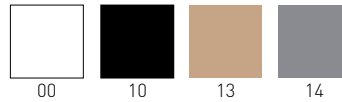

base110	BROLLER._/H110		0.2m ³ / 11.30kg / 1pcs
base110+20	BROLLER._/H110+20		0.2m ³ / 31.30kg / 1pcs
base110 Led	BROLLER._/H110L		0.2m ³ / 14.45kg / 1pcs

Ø 60 (23 1/2")	diam.60	TROLC040._-/H110		0.28m ³ / 20.6kg / 1pcs
	diam.60	TROLC040._-/H110L		0.28m ³ / 23.8kg / 1pcs

Ø 68 (27")	diam.68	TROLC048._-/H110		0.31m ³ / 24.1kg / 1pcs
	diam.68	TROLC048._-/H110L		0.31m ³ / 27.3kg / 1pcs

Ø 80 (31 1/2")	diam.80	TROLC056._-/H110		0.5m ³ / 26.1kg / 1pcs
	diam.80	TROLC056._-/H110L		0.5m ³ / 29.3kg / 1pcs

60 (23 1/2")	60x60	TROLC044._-/H110		0.28m ³ / 22.8kg / 1pcs
	60x60	TROLC044._-/H110L		0.28m ³ / 26kg / 1pcs

68 (27")	68x68	TROLC052._-/H110		0.31m ³ / 25.6kg / 1pcs
	68x68	TROLC052._-/H110L		0.31m ³ / 28.8kg / 1pcs

79 (31")	79x79	TROLC060._-/H110		0.5m ³ / 27.6kg / 1pcs
	79x79	TROLC060._-/H110L		0.5m ³ / 30.8kg / 1pcs

ROLLER

Studio Eurolinea Design

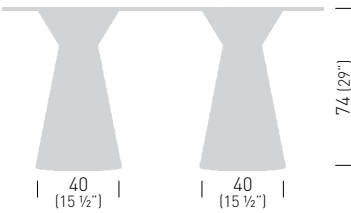
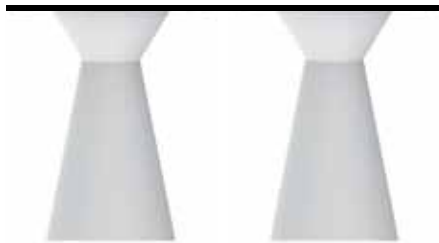

74 (29")

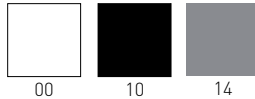

Compactop Color / Colore Piano Compactop

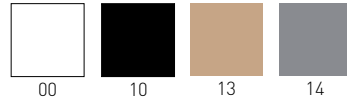

Fullcolor white top available on demand.
Bianco Fullcolor disponibile su richiesta.

Technopolymer Base Color / Colore Base Tecnopolimero



230V – 50Hz
 1 X 16W – Led Modul
 IP 65

Table Dimensions	Base	Product Code	Volume / Weight
120 (47") x 50 (19 1/2")	base74	BROLLER.__/2H74	0.26m ³ / 22.60kg / 1pcs
120 (47") x 80 (31 1/2")	base74	TROLC072.__-/2H74	0.56m ³ / 38.1kg / 1pcs
120 (47") x 80 (31 1/2")	base74	TROLC076.__-/2H74	0.56m ³ / 39.1kg / 1pcs
140 (55") x 70 (27 1/2")	base74	TROLC080.__-/2H74	0.66m ³ / 42.6kg / 1pcs
159 (62 1/2") x 79 (31")	base74	TROLC084.__-/2H74	0.94m ³ / 45.6kg / 1pcs

Table Dimensions	Base	Product Code	Volume / Weight
120 (47") x 50 (19 1/2")	base110	BROLLER.__/2H110	0.38m ³ / 30.2kg / 1pcs
120 (47") x 80 (31 1/2")	base110	TROLC072.__-/H110	0.66m ³ / 45.7kg / 1pcs
120 (47") x 80 (31 1/2")	base110	TROLC076.__-/H110	0.66m ³ / 46.7kg / 1pcs
140 (55") x 70 (27 1/2")	base110	TROLC080.__-/H110	0.84m ³ / 50.2kg / 1pcs
159 (62 1/2") x 79 (31")	base110	TROLC084.__-/H110	1.04m ³ / 53.2kg / 1pcs





JACKIE

Studio Eurolinea Design

Metal table top and stackable
metal frame.
Suitable for outdoor use.

Tavolo impilabile con piano in
metallo verniciato, adatto anche
all'uso esterno.



Top and Frame Color / Colore Piano e Struttura



00



10



21



43

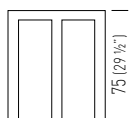

diam.60

TJAKI027._/H75

 0.41m³ / 14kg / 2pcs

TKITT is a table collection, suitable for outdoor use. Tables are made with techno polymer tops in different shapes and sizes, combined with technopolymer-metal co-injected bases and anodized columns.

Technopolymer table top colors match perfectly the colors of the Gaber seating collection.

TKITT è una collezione di tavoli adatti anche all'uso esterno. I tavoli sono realizzati con piani in tecnopolimero di varie dimensioni e forme, combinati a basamenti in metallo sovrastampato con tecnopolimero e colonne in alluminio anodizzato. I colori dei piani dei tavoli corrispondono ai colori della vasta collezione di sedute Gaber.

TKITT COLLECTION





TKITT COLLECTION





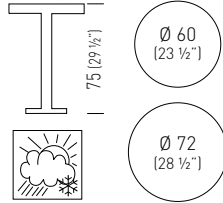

TKITT.BG3K

H75 Table with technopolymer top, BG3K 3-spur metal-technopolymer co-injected table base, Ø 80mm anodized aluminum column.



Tavolo con piano in tecnopolimero H75, basamento BG3K a tre razze in metallo sovrastampato con tecnopolimero, colonna in alluminio anodizzato Ø 80mm.



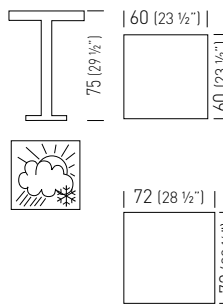

- TKITT04._/BG3K  0.13m³ / 13.8kg / 1pcs
- TKITT04._/BG3K.10  0.13m³ / 13.8kg / 1pcs



- TKITT03._/BG3K  0.15m³ / 14.5kg / 1pcs
- TKITT03._/BG3K.10  0.15m³ / 14.5kg / 1pcs

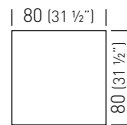

- TKITT20._/BG3K  0.13m³ / 14.6kg / 1pcs
- TKITT20._/BG3K.10  0.13m³ / 14.6kg / 1pcs

- TKITT06._/BG3K  0.15m³ / 15.8kg / 1pcs
- TKITT06._/BG3K.10  0.15m³ / 15.8kg / 1pcs



- TKITT23._/BG3K  0.16m³ / 18.4kg / 1pcs
- TKITT23._/BG3K.10  0.16m³ / 18.4kg / 1pcs

Top Color / Colore Piano





TKITT.BG3L

H75 Table with technopolymer top, BG3L 3-spur metal-technopolymer co-injected table base, Ø 80mm anodized aluminum column.

Tavolo con piano in tecnopolimero H75, basamento BG3L a tre razze in metallo sovrastampato con tecnopolimero, colonna in alluminio anodizzato Ø 80mm.

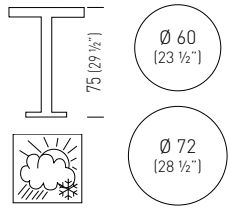

- TKITT04.__/BG3L 0.14m³ / 15kg / 1pcs
- TKITT04.__/BG3L.10 0.14m³ / 15kg / 1pcs
- TKITT03.__/BG3L 0.16m³ / 15.7kg / 1pcs
- TKITT03.__/BG3L.10 0.16m³ / 15.7kg / 1pcs

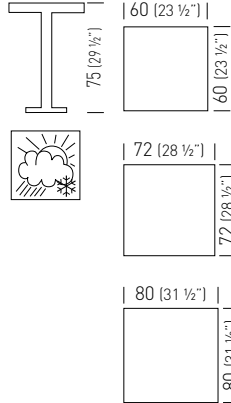

- TKITT20.__/BG3L 0.14m³ / 15.8kg / 1pcs
- TKITT20.__/BG3L.10 0.14m³ / 15.8kg / 1pcs
- TKITT06.__/BG3L 0.16m³ / 17kg / 1pcs
- TKITT06.__/BG3L.10 0.16m³ / 17kg / 1pcs
- TKITT23.__/BG3L 0.17m³ / 19.6kg / 1pcs
- TKITT23.__/BG3L.10 0.17m³ / 19.6kg / 1pcs

TKITT.BGA3L

H110 Table with technopolymer top, BG3L 3-spur metal-technopolymer co-injected table base, Ø 80mm anodized aluminum column.

Tavolo con piano in tecnopolimero H110, basamento BG3L a tre razze in metallo sovrastampato con tecnopolimero, colonna in alluminio anodizzato Ø 80mm.

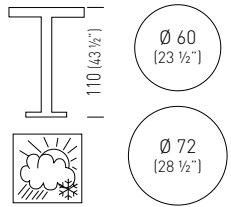

- TKITT04.__/BGA3L 0.18m³ / 15.8kg / 1pcs
- TKITT04.__/BGA3L.10 0.18m³ / 15.8kg / 1pcs
- TKITT03.__/BGA3L 0.20m³ / 16.5kg / 1pcs
- TKITT03.__/BGA3L.10 0.20m³ / 16.5kg / 1pcs

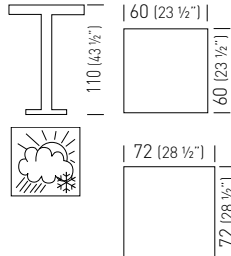

- TKITT20.__/BGA3L 0.18m³ / 16.6kg / 1pcs
- TKITT20.__/BGA3L.10 0.18m³ / 16.6kg / 1pcs
- TKITT06.__/BGA3L 0.20m³ / 17.8kg / 1pcs
- TKITT06.__/BGA3L.10 0.20m³ / 17.8kg / 1pcs

Top Color / Colore Piano





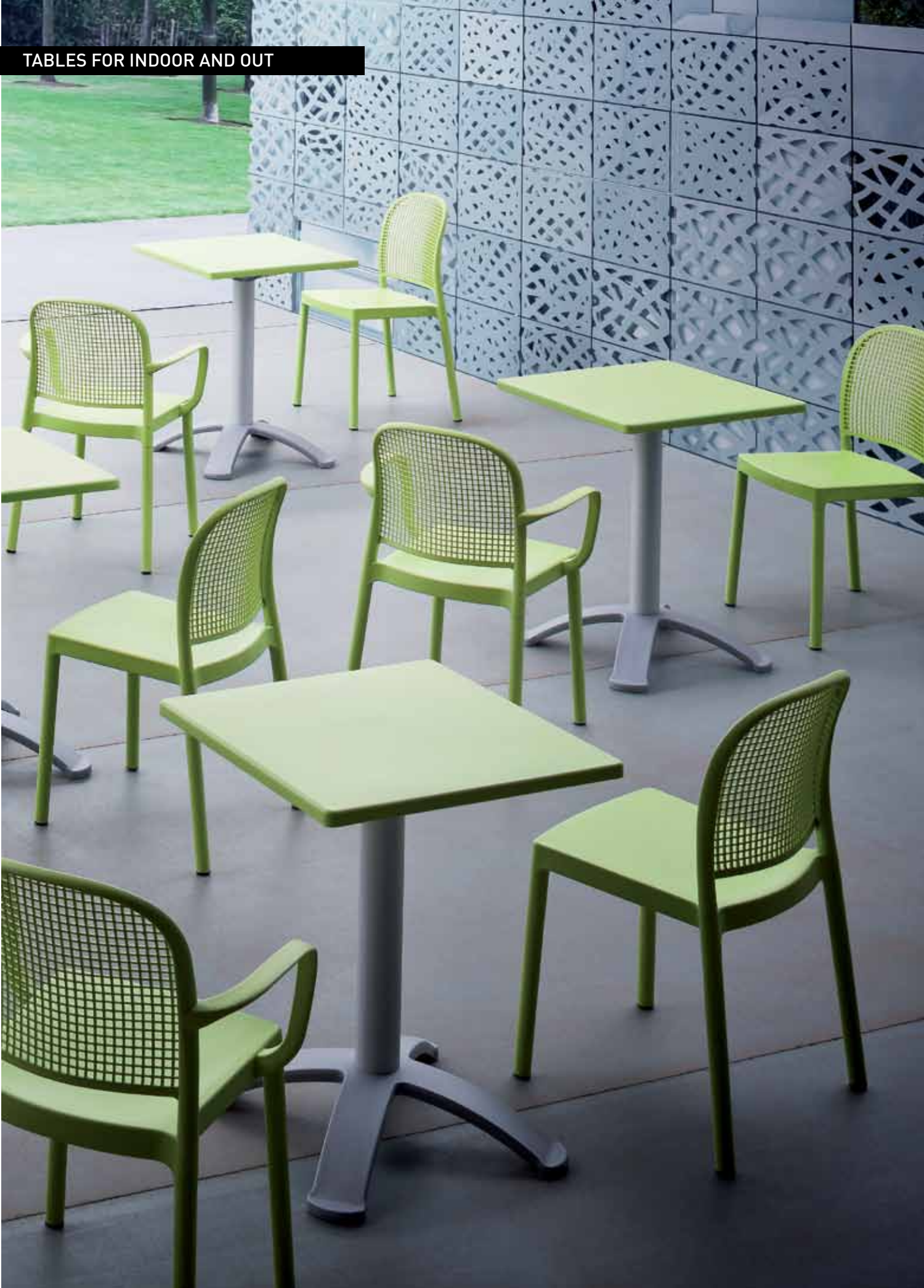







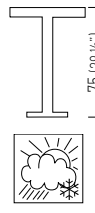



TABLES FOR INDOOR AND OUT

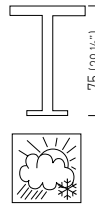
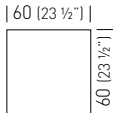

TKITT.BG4K

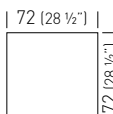
H75 Table with technopolymer top, BG4K 4-spur metal-technopolymer co-injected table base, Ø 80mm anodized aluminum column.

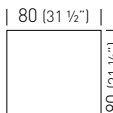









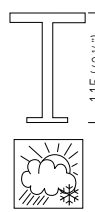

Tavolo con piano in tecnopolimero H75, basamento BG4K a quattro razze in metallo sovrastampato con tecnopolimero, colonna in alluminio anodizzato Ø 80mm.

			■ TKITT04._/BG4K  0.13m ³ / 16.5kg / 1pcs ■ TKITT04._/BG4K.10  0.13m ³ / 16.5kg / 1pcs
			■ TKITT03._/BG4K  0.15m ³ / 17.2kg / 1pcs ■ TKITT03._/BG4K.10  0.15m ³ / 17.2kg / 1pcs
			■ TKITT20._/BG4K  0.13m ³ / 17.3kg / 1pcs ■ TKITT20._/BG4K.10  0.13m ³ / 17.3kg / 1pcs
			■ TKITT06._/BG4K  0.15m ³ / 18.5kg / 1pcs ■ TKITT06._/BG4K.10  0.15m ³ / 18.5kg / 1pcs
			■ TKITT23._/BG4K  0.16m ³ / 21.1kg / 1pcs ■ TKITT23._/BG4K.10  0.16m ³ / 21.1kg / 1pcs

TKITT.BGA4K

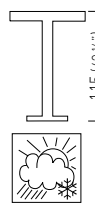
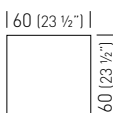
H115 Table with technopolymer top, BG4K 4-spur metal-technopolymer co-injected table base, Ø 80mm anodized aluminum column.

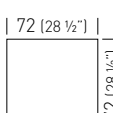
Tavolo con piano in tecnopolimero H115, basamento BG4K a quattro razze in metallo sovrastampato con tecnopolimero, colonna in alluminio anodizzato Ø 80mm.

			■ TKITT04._/BGA4K  0.17m ³ / 17.3kg / 1pcs ■ TKITT04._/BGA4K.10  0.17m ³ / 17.3kg / 1pcs
			■ TKITT03._/BGA4K  0.19m ³ / 18kg / 1pcs ■ TKITT03._/BGA4K.10  0.19m ³ / 18kg / 1pcs
			■ TKITT20._/BGA4K  0.17m ³ / 18.1kg / 1pcs ■ TKITT20._/BGA4K.10  0.17m ³ / 18.1kg / 1pcs
			■ TKITT06._/BGA4K  0.19m ³ / 19.3kg / 1pcs ■ TKITT06._/BGA4K.10  0.19m ³ / 19.3kg / 1pcs

Top Color / Colore Piano



TABLES FOR INDOOR AND OUT

TKITT.BG4J

H75 Table with technopolymer top, BG4J 4-spur metal-technopolymer co-injected table base, 80x80mm anodized aluminum column.

Tavolo con piano in tecnopolimero H75, basamento BG4J a quattro razze in metallo sovrastampato con tecnopolimero, colonna in alluminio anodizzato 80x80mm.

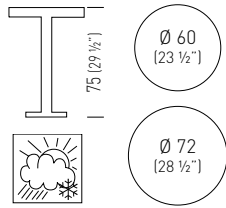

- TKITT04.__/BG4J 0.16m³ / 16.8kg / 1pcs
- TKITT04.__/BG4J.10 0.16m³ / 16.8kg / 1pcs

- TKITT03.__/BG4J 0.18m³ / 17.5kg / 1pcs
- TKITT03.__/BG4J.10 0.18m³ / 17.5kg / 1pcs

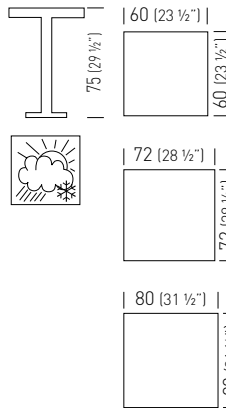

- TKITT20.__/BG4J 0.16m³ / 17.6kg / 1pcs
- TKITT20.__/BG4J.10 0.16m³ / 17.6kg / 1pcs

- TKITT06.__/BG4J 0.18m³ / 18.8kg / 1pcs
- TKITT06.__/BG4J.10 0.18m³ / 18.8kg / 1pcs

- TKITT23.__/BG4J 0.19m³ / 21.4kg / 1pcs
- TKITT23.__/BG4J.10 0.19m³ / 21.4kg / 1pcs

TKITT.BGPK

H75 folding table with technopolymer top, BG4J 4-spur metal-technopolymer co-injected base, Ø 80mm anodized aluminum column with flip-top mechanism.

Tavolo pieghevole con piano in tecnopolimero H75, basamento BGPK a quattro razze in metallo sovrastampato con tecnopolimero, colonna in alluminio anodizzato Ø 80mm.

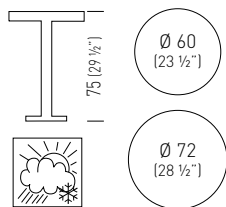

- TKITT04.__/BGPK 0.13m³ / 17.5kg / 1pcs
- TKITT04.__/BGPK.10 0.13m³ / 17.5kg / 1pcs

- TKITT03.__/BGPK 0.15m³ / 18.2kg / 1pcs
- TKITT03.__/BGPK.10 0.15m³ / 18.2kg / 1pcs

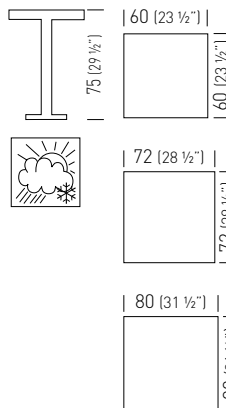

- TKITT20.__/BGPK 0.13m³ / 18.3kg / 1pcs
- TKITT20.__/BGPK.10 0.13m³ / 18.3kg / 1pcs

- TKITT06.__/BGPK 0.15m³ / 19.5kg / 1pcs
- TKITT06.__/BGPK.10 0.15m³ / 19.5kg / 1pcs

- TKITT23.__/BGPK 0.16m³ / 22.1kg / 1pcs
- TKITT23.__/BGPK.10 0.16m³ / 22.1kg / 1pcs

Top Color / Colore Piano





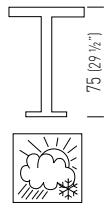

TKITT.BGPJ

H75 folding table with technopolymer top, B64J 4-spur metal-technopolymer co-injected base, 80x80mm anodized aluminum column with flip-top mechanism.



Tavolo pieghevole con piano in tecnopolimero H75, basamento B6PK a quattro razze in metallo sovrastampato con tecnopolimero, colonna in alluminio anodizzato 80x80mm.



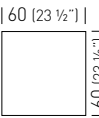
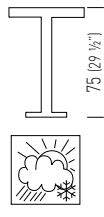

- TKITT04._/BGPJ  0.16m³ / 17.8kg / 1pcs
- TKITT04._/BGPJ.10  0.16m³ / 17.8kg / 1pcs

- TKITT03._/BGPJ  0.18m³ / 18.5kg / 1pcs
- TKITT03._/BGPJ.10  0.18m³ / 18.5kg / 1pcs



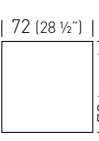

- TKITT20._/BGPJ  0.16m³ / 18.6kg / 1pcs
- TKITT20._/BGPJ.10  0.16m³ / 18.6kg / 1pcs

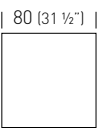

- TKITT06._/BGPJ  0.18m³ / 19.8kg / 1pcs
- TKITT06._/BGPJ.10  0.18m³ / 19.8kg / 1pcs



- TKITT23._/BGPJ  0.19m³ / 22.4kg / 1pcs
- TKITT23._/BGPJ.10  0.19m³ / 22.4kg / 1pcs

Top Color / Colore Piano





TKITT.BG4IP

Folding and stacking H75 table with technopolymer top, BG4IP 4-spur metal-technopolymer co-injected table base, Ø 80mm anodized aluminum column with flip-top mechanism and adjustable feet.

Tavolo pieghevole e accatastabile con piano in tecnopolimero H75, basamento BG4IP a quattro razze in metallo sovrastampato con tecnopolimero, colonna in alluminio anodizzato Ø 80mm e piedini regolabili.

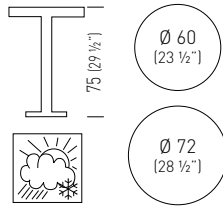

- TKITT04._/BG4IP 0.13m³ / 14kg / 1pcs
- TKITT04._/BG4IP.10 0.13m³ / 14kg / 1pcs

- TKITT03._/BG4IP 0.15m³ / 14.7kg / 1pcs
- TKITT03._/BG4IP.10 0.15m³ / 14.7kg / 1pcs

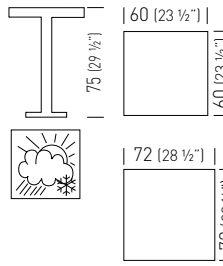

- TKITT20._/BG4IP 0.13m³ / 14.8kg / 1pcs
- TKITT20._/BG4IP.10 0.13m³ / 14.8kg / 1pcs

- TKITT06._/BG4IP 0.15m³ / 16kg / 1pcs
- TKITT06._/BG4IP.10 0.15m³ / 16kg / 1pcs

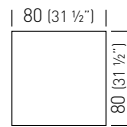

- TKITT23._/BG4IP 0.16m³ / 18.5kg / 1pcs
- TKITT23._/BG4IP.10 0.16m³ / 18.5kg / 1pcs

Top Color / Colore Piano





TKITT.BTK

H75 Table with technopolymer top, round BTK metal-technopolymer co-injected base, Ø 80mm anodized aluminum column.

Tavolo con piano in tecnopolimero H75, basamento BTK rotondo in metallo sovrastampato con tecnopolimero, colonna in alluminio anodizzato Ø 80mm.

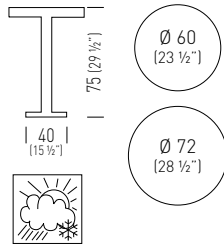

- | | | |
|--------------------|--|------------------------|
| ■ TKITT04._/BTK | | 0.16m³ / 13.8kg / 1pcs |
| ■ TKITT04._/BTK.10 | | 0.16m³ / 13.8kg / 1pcs |
| ■ TKITT03._/BTK | | 0.18m³ / 14.5kg / 1pcs |
| ■ TKITT03._/BTK.10 | | 0.18m³ / 14.5kg / 1pcs |

TKITT.BTAK

H110 Table with technopolymer top, round BTAK metal-technopolymer co-injected base, Ø 80mm anodized aluminum column.

Tavolo con piano in tecnopolimero H110, basamento BTAK rotondo in metallo sovrastampato con tecnopolimero, colonna in alluminio anodizzato Ø 80mm.

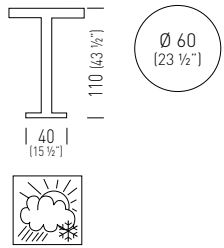

- | | | |
|---------------------|--|------------------------|
| ■ TKITT04._/BTAK | | 0.17m³ / 14.8kg / 1pcs |
| ■ TKITT04._/BTAK.10 | | 0.17m³ / 14.8kg / 1pcs |

Top Color / Colore Piano







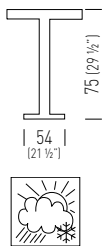

TKITT.BTK54

H75 Table with technopolymer top, round BTK54 metal-technopolymer co-injected table base, Ø 80mm anodized aluminum column.

Tavolo con piano in tecnopolimero H75, basamento BTK54 rotondo in metallo sovrastampato con tecnopolimero, colonna in alluminio anodizzato Ø 80mm.







- TKITT04.__/BTK54  0.16m³ / 16.3kg / 1pcs
- TKITT04.__/BTK54.10  0.16m³ / 16.3kg / 1pcs
- TKITT03.__/BTK54  0.18m³ / 17kg / 1pcs
- TKITT03.__/BTK54.10  0.18m³ / 17kg / 1pcs

TKITT.BTAK54

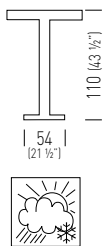
H110 Table with technopolymer top, round BTK54 metal-technopolymer co-injected table base, Ø 80mm anodized aluminum column.

Tavolo con piano in tecnopolimero H110, basamento BTAK54 rotondo in metallo sovrastampato con tecnopolimero, colonna in alluminio anodizzato Ø 80mm.



- TKITT04.__/BTAK54  0.17m³ / 17.3kg / 1pcs
- TKITT04.__/BTAK54.10  0.17m³ / 17.3kg / 1pcs
- TKITT03.__/BTAK54  0.19m³ / 18kg / 1pcs
- TKITT03.__/BTAK54.10  0.19m³ / 18kg / 1pcs

Top Color / Colore Piano



TABLES FOR INDOOR AND OUT





TKITT.DPBT54

H110 double table with technopolymer tops, round DPBT54 metal-technopolymer co-injected base, Ø 80mm anodized aluminum column.

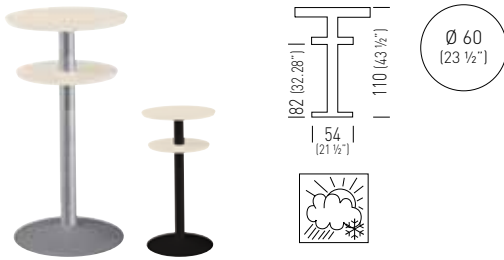
Tavolo con doppio piano in tecnopolimero H110, basamento DPBT54 rotondo in metallo sovrastampato con tecnopolimero, colonna in alluminio anodizzato Ø 80mm.



- TKITT08._/DPBT54  0.15m³ / 16.5kg / 1pcs
- TKITT08._/DPBT54.10  0.15m³ / 16.5kg / 1pcs

Top Color / Colore Piano





TKITT.BRK

H75 Table with technopolymer top, round BRK metal-technopolymer co-injected base, Ø 80mm anodized aluminum column.

Tavolo con piano in tecnopolimero H75, basamento BRK rotondo in metallo sovrastampato con tecnopolimero, colonna in alluminio anodizzato Ø 80mm.

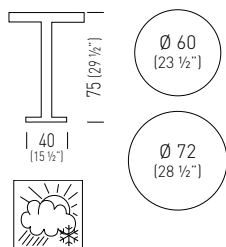

- | | |
|---------------------|------------------------|
| ■ TKITT04.__/BRK | 0.13m³ / 14.3kg / 1pcs |
| ■ TKITT04.__/BRK.10 | 0.13m³ / 14.3kg / 1pcs |
| ■ TKITT03.__/BRK | 0.15m³ / 15kg / 1pcs |
| ■ TKITT03.__/BRK.10 | 0.15m³ / 15kg / 1pcs |

Top Color / Colore Piano





TKITT.BQJ

H75 Table with technopolymer top, square BQJ metal-technopolymer co-injected table base, 80x80mm anodized aluminum column.

Tavolo con piano in tecnopolimero H75, basamento BQJ quadrato in metallo sovrastampato con tecnopolimero, colonna in alluminio anodizzato 80x80mm.

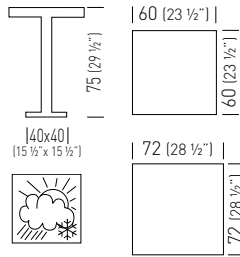

- TKITT20.__/BQJ 0.13m³ / 17.1kg / 1pcs
- TKITT20.__/BQJ.10 0.13m³ / 17.1kg / 1pcs

- TKITT06.__/BQJ 0.15m³ / 18.3kg / 1pcs
- TKITT06.__/BQJ.10 0.15m³ / 18.3kg / 1pcs

TKITT.BQAJ

H105 Table with technopolymer top, square BQJ metal-technopolymer co-injected table base, 80x80mm anodized aluminum column.

Tavolo con piano in tecnopolimero H105, basamento BQJ quadrato in metallo sovrastampato con tecnopolimero, colonna in alluminio anodizzato 80x80mm.

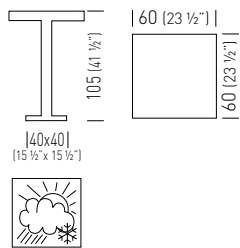

- TKITT20.__/BQAJ 0.14m³ / 17.6kg / 1pcs
- TKITT20.__/BQAJ.10 0.14m³ / 17.6kg / 1pcs

Top Color / Colore Piano





TIMPT.STAKY

Stackable table collection, suitable for outdoor use.
Techno polymer tops and anodized aluminum frames.

Collezione di tavoli impilabili, adatti all'uso esterno. I tavoli sono realizzati con piani in tecnopolimero e struttura in alluminio anodizzato.

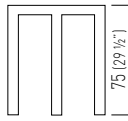

TIMPT04._/H75

0.03m³ / 7.1kg / 1pcs



TIMPT03._/H75

0.08m³ / 7.3kg / 1pcs

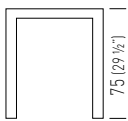

60 (23 1/2")

TIMPT20._/H75

0.05m³ / 7.6kg / 1pcs



80 (31 1/2")

TIMPT23._/H75

0.09m³ / 8kg / 1pcs

Top Color / Colore Piano



00



01



04



06



09



10



14



42



52



99

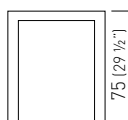

72 (28 1/2")

TIMPT06._/H75

0.08m³ / 7.6kg / 1pcs



72 (28 1/2")

Top Color / Colore Piano



01



TCONT.STEADY

Counterbalanced tables collection, suitable for outdoor use.
Techno polymer tops and anodized aluminum frames.

Collezione di tavoli a contrappesi, adatti all'uso esterno. I tavoli sono realizzati con piani in tecnopolimero e struttura in alluminio anodizzato.

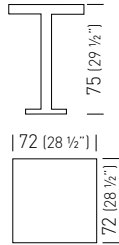

TCONT06._/H75

0.08m³ / 12.8kg / 1pcs

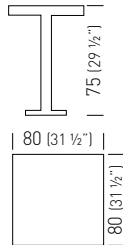

TCONT23._/H75

0.10m³ / 13kg / 1pcs

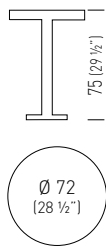

TCONT03._/H75

0.08m³ / 12.6kg / 1pcs

Top Color / Colore Piano



00



01



04



06



09



10



14



42



52









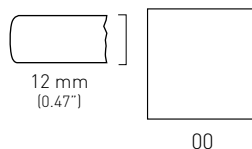
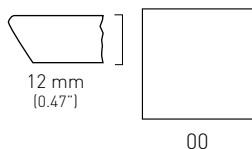

99

TABLE TOPS

COMPACTOP SURFACES FULLCOLOR



Sizes / Misure	Code / Codice	
 Ø 60 (23 ½")	PTC301.00	0.054m³ / 11kg / 2pcs
Ø 68 (27")	PTC303.00	0.074m³ / 18kg / 2pcs
Ø 80 (31 ½")	PTC305.00	0.09m³ / 22kg / 2pcs
Ø 100 (39 ½")	PTC308.00	0.20m³ / 31kg / 2pcs
Ø 120 (47")	PTC309.00	0.26m³ / 44kg / 2pcs
Ø 140 (55")	PTC315.00	0.30m³ / 50kg / 2pcs
 59x59 (23"x23")	PTC302.00	0.054m³ / 15kg / 2pcs
68x68 (27"x27")	PTC304.00	0.074m³ / 21kg / 2pcs
79x79 (31"x31")	PTC306.00	0.090m³ / 25kg / 2pcs
89x89 (35"x35")	PTC307.00	0.11m³ / 27kg / 2pcs
 120x50 (47"x19 ½")	PTC310.00	0.20m³ / 31kg / 2pcs
140x70 (55"x27 ½")	PTC311.00	0.20m³ / 40kg / 2pcs
120x80 (47"x31 ½")	PTC312.00	0.20m³ / 33kg / 2pcs
159x79 (62 ½"x31")	PTC314.00	0.26m³ / 46kg / 2pcs

Sizes / Misure	Code / Codice	
 Ø 60 (23 ½")	PTC201.00	0.054m³ / 11kg / 2pcs
Ø 68 (27")	PTC203.00	0.074m³ / 18kg / 2pcs
Ø 80 (31 ½")	PTC205.00	0.09m³ / 22kg / 2pcs
Ø 100 (39 ½")	PTC208.00	0.20m³ / 31kg / 2pcs
Ø 120 (47")	PTC209.00	0.26m³ / 44kg / 2pcs
Ø 140 (55")	PTC215.00	0.30m³ / 50kg / 2pcs
 59x59 (23"x23")	PTC202.00	0.054m³ / 15kg / 2pcs
68x68 (27"x27")	PTC204.00	0.074m³ / 21kg / 2pcs
79x79 (31"x31")	PTC206.00	0.090m³ / 25kg / 2pcs
89x89 (35"x35")	PTC207.00	0.11m³ / 27kg / 2pcs
 120x50 (47"x19 ½")	PTC210.00	0.20m³ / 31kg / 2pcs
140x70 (55"x27 ½")	PTC211.00	0.20m³ / 40kg / 2pcs
120x80 (47"x31 ½")	PTC212.00	0.20m³ / 33kg / 2pcs
159x79 (62 ½"x31")	PTC214.00	0.26m³ / 46kg / 2pcs

ABOUT COMPACTOP: MUCH MORE THAN A MERE SURFACE

Gaber Compactops are made of high-pressure laminate, consisting of numerous layers of paper saturated with thermosetting resins and bonded through the combined action of heat and high pressure. The paper used on Compactop (around 70% of the complete composition) comes from production processes that conform with the FSC chain of custody; phenolic and melamine resins are all strictly water-based.

The result is a stable, non-reactive, homogenous, non-porous, antistatic, high-density product with a totally distinct physical and chemical profile from that of its constituent parts. Thanks to the heat and high-pressure treatment it they undergo, Gaber Compactops are exceptionally tough and resistant to scratches, abrasions, chemicals and heat, making them ideal for a wide range of contract applications. Tops come pre-bored for Gaber kit bases.

Gaber Compactops conform to EN 438/1. According to this norm, the most important characteristics of Gaber Compactops are: their resistance to bumps, scratches, and wear and tear; color-fastness; easy cleanability; suitability suitable for contact with food and general hygiene.

MAINTENANCE & CLEANING

No specific maintenance other than normal cleaning is required. The compact, non porous surface can easily be cleaned and disinfected with hot water, steam and any common non-abrasive household detergents and disinfectants, as long as these are not highly alkaline. Just a couple of precautions are necessary: avoid using strong acids and bases and avoid wiping with highly abrasive substances or equipment.

CHE COS'È IL COMPACTOP? MOLTO PIÙ DI UNA SEMPLICE SUPERFICIE

Il Compactop che Gaber utilizza per i propri tavoli è un laminato realizzato ad alta pressione, costituito da numerosi strati di carta impregnati con resine termoindurenti fenoliche e melaminiche, compattati attraverso l'azione combinata di calore ed alta pressione. Le carte utilizzate (circa il 70% della composizione dei piani) derivano da processi che seguono il protocollo della catena di custodia certificata FSC; le resine fenoliche e melaminiche sono tutte rigorosamente realizzate su base acquosa.

Il risultato è un prodotto stabile, non reattivo, omogeneo, non poroso, antistatico e di alta densità. Grazie al trattamento di alta temperatura e pressione cui è sottoposto, il Compactop è un materiale estremamente robusto: resistente a graffi, urti, abrasioni, sostanze chimiche e calore; caratteristiche che lo rendono il materiale ideale per una vasta gamma di applicazioni. I fissaggi dei piani Compactop sono già predisposti per i basamenti Gaber.

Il Compactop è conforme alla norma EN 438/1, secondo la quale, queste sono le principali caratteristiche di qualità di questo materiale: Resistente all'impatto, ai graffi e all'usura, stabile alla luce, facile da pulire, igienico, adatto al contatto con i cibi.

MANUTENZIONE E PULIZIA

Il Compactop non richiede alcuna manutenzione particolare al di là della normale pulizia.

La sua superficie compatta e non porosa può essere facilmente pulita e disinfettata con acqua calda, vapore e tutti i tipi dei più comuni detergenti e disinfettanti per uso domestico, purché non alcalini. Sono necessarie solo poche precauzioni, quali evitare l'uso di acidi o basi forti, evitare di strofinare con sostanze o strumenti fortemente abrasivi.

COMPACTOP SURFACES

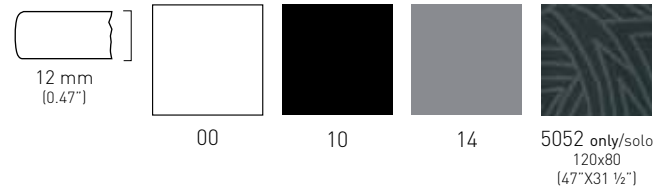
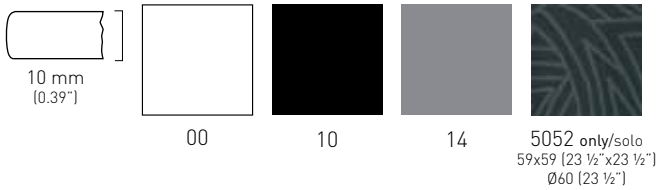

	Sizes / Misure	Code / Codice	
	Ø 60 (23 1/2")	PTC101._	0.054m³ / 11kg / 2pcs
	Ø 68 (27")	PTC103._	0.074m³ / 18kg / 2pcs
	59x59 (23"x23")	PTC102._	0.054m³ / 15kg / 2pcs
	68x68 (27"x27")	PTC104._	0.074m³ / 21kg / 2pcs
	79x79 (31"x31")	PTC106._	0.090m³ / 25kg / 2pcs
	89x89 (35"x35")	PTC107._	0.11m³ / 27kg / 2pcs

	Sizes / Misure	Code / Codice	
	Ø 80 (31 1/2")	PTC105._	0.09m³ / 22kg / 2pcs
	Ø 100 (39 1/2")	PTC108._	0.20m³ / 31kg / 2pcs
	Ø 120 (47")	PTC109._	0.26m³ / 44kg / 2pcs
	Ø 140 (55")	PTC115._	0.30m³ / 50kg / 2pcs
	120x50 (47"x19 1/2")	PTC110._	0.20m³ / 31kg / 2pcs
	140x70 (55"x27 1/2")	PTC111._	0.20m³ / 40kg / 2pcs
	120x80 (47"x31 1/2")	PTC112._	0.20m³ / 33kg / 2pcs
	159x79 (62 1/2"x31")	PTC114._	0.26m³ / 46kg / 2pcs

ABOUT COMPACTOP: MUCH MORE THAN A MERE SURFACE

Gaber Compactops are made of high-pressure laminate, consisting of numerous layers of paper saturated with thermosetting resins and bonded through the combined action of heat and high pressure. The paper used on Compactop (around 70% of the complete composition) comes from production processes that conform with the FSC chain of custody; phenolic and melamine resins are all strictly water-based.

The result is a stable, non-reactive, homogenous, non-porous, antistatic, high-density product with a totally distinct physical and chemical profile from that of its constituent parts. Thanks to the heat and high-pressure treatment it they undergo, Gaber Compactops are exceptionally tough and resistant to scratches, abrasions, chemicals and heat, making them ideal for a wide range of contract applications. Tops come pre-bored for Gaber kit bases.

Gaber Compactops conform to EN 438/1. According to this norm, the most important characteristics of Gaber Compactops are: their resistance to bumps, scratches, and wear and tear; color-fastness; easy cleanability; suitability suitable for contact with food and general hygiene.

MAINTENANCE & CLEANING

No specific maintenance other than normal cleaning is required. The compact, non porous surface can easily be cleaned and disinfected with hot water, steam and any common non-abrasive household detergents and disinfectants, as long as these are not highly alkaline. Just a couple of precautions are necessary: avoid using strong acids and bases and avoid wiping with highly abrasive substances or equipment.

CHE COS'È IL COMPACTOP? MOLTO PIÙ DI UNA SEMPLICE SUPERFICIE

Il Compactop che Gaber utilizza per i propri tavoli è un laminato realizzato ad alta pressione, costituito da numerosi strati di carta impregnati con resine termoindurenti fenoliche e melaminiche, compattati attraverso l'azione combinata di calore ed alta pressione. Le carte utilizzate (circa il 70% della composizione dei piani) derivano da processi che seguono il protocollo della catena di custodia certificata FSC; le resine fenoliche e melaminiche sono tutte rigorosamente realizzate su base acquosa.

Il risultato è un prodotto stabile, non reattivo, omogeneo, non poroso, antistatico e di alta densità. Grazie al trattamento di alta temperatura e pressione cui è sottoposto, il Compactop è un materiale estremamente robusto: resistente a graffi, urti, abrasioni, sostanze chimiche e calore; caratteristiche che lo rendono il materiale ideale per una vasta gamma di applicazioni. I fissaggi dei piani Compactop sono già predisposti per i basamenti Gaber.

Il Compactop è conforme alla norma EN 438/1, secondo la quale, queste sono le principali caratteristiche di qualità di questo materiale: Resistente all'impatto, ai graffi e all'usura, stabile alla luce, facile da pulire, igienico, adatto al contatto con i cibi.

MANUTENZIONE E PULIZIA



Il Compactop non richiede alcuna manutenzione particolare al di là della normale pulizia.

La sua superficie compatta e non porosa può essere facilmente pulita e disinfettata con acqua calda, vapore e tutti i tipi dei più comuni detergenti e disinfettanti per uso domestico, purché non alcalini. Sono necessarie solo poche precauzioni, quali evitare l'uso di acidi o basi forti, evitare di strofinare con sostanze o strumenti fortemente abrasivi.

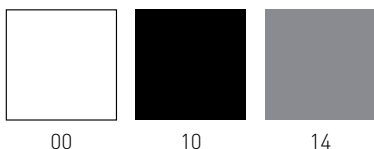
IRON SURFACES



00 10 14

	Sizes / Misure	Code / Codice	
	60x60 (23 1/2" X 23 1/2")	PTI102_	0.054m ³ / 16.4kg / 2pcs
	70x70 (27 1/2" X 27 1/2")	PTI104_	0.074m ³ / 21.6kg / 2pcs
	80x80 (31 1/2" X 31 1/2")	PTI106_	0.090m ³ / 22kg / 2pcs
	120x80 (47" X 31 1/2")	PTI112_	0.20m ³ / 31.2kg / 2pcs

ABOUT IRON TABLE TOPS

Gaber's Iron table tops are made of composite materials: a non-deformable water-repellent multilayer wood-based core, covered in steel. The slim line result is elegant, stylish and practical. Iron tops come pre-bored for Gaber kit bases. These tough materials make iron tops suitable for indoor as well as outdoor use.

MAINTENANCE & CLEANING

Gaber's Iron table tops do not require any special maintenance beyond normal cleaning.

Its surface can be easily cleaned with a soft cloth dampened with water, even with household cleaning detergent, provided they are not alkaline and generally aggressive. Avoid the use of strong acids or bases, avoid rubbing with abrasive substances or devices.

COSA SONO I PIANI DEI TAVOLI IRON?

I sistemi Iron che Gaber utilizza per i propri piani dei tavoli sono realizzati da materiali compositi: il cuore del sistema è realizzato con un materiale multistrato, a base legnosa, resistente all'umidità, di grande stabilità. Il rivestimento in acciaio e lo spessore contenuto rendono il prodotto elegante, raffinato e pratico. I fissaggi dei piani Iron sono già predisposti per i basamenti Gaber. Le finiture disponibili lo rendono adatto anche all'uso per outdoor, grazie all'ottimale resistenza agli agenti atmosferici.



MANUTENZIONE E PULIZIA

I piani Iron di Gaber non richiedono alcuna manutenzione particolare al di là della normale pulizia.

La sua superficie può essere facilmente pulita con un panno morbido imbevuto di acqua, anche con detersivi per uso domestico, purché non alcalini ed in genere aggressivi. Evitare l'uso di acidi o basi forti, evitare di strofinare con sostanze o strumenti abrasivi.

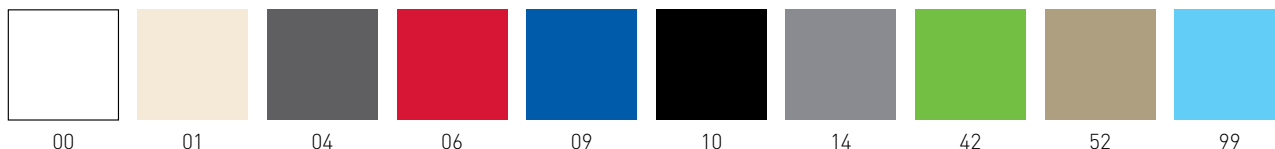
TECHNO POLYMER TABLE TOPS



	Sizes / Misure	Code / Codice	
	Ø 60 (23 ½")	PTT04._	0.054m³ / 4kg / 1pcs
	Ø 72 (28 ½")	PTT03._	0.074m³ / 4.7kg / 1pcs
	60x60 (23 ½"X23 ½")	PTT20._	0.054m³ / 4.8kg / 1pcs
	72x72 (28 ½"X28 ½")	PTT06._	0.074m³ / 6kg / 1pcs
	80x80 (31 ½"X31 ½")w	PTT23._	0.090m³ / 8.6kg / 1pcs

ABOUT TECHNO POLYMER TABLE-TOPS

The Techno Polymer Compounds Gaber uses on its table tops have high structural, heat and abrasion resistance. Gaber's technopolymer table tops are practical, shock-resistant, colorful and inexpensive.

Gaber technopolymers are non-toxic, stain-resistant, antistatic and UV-resistant and consequently have excellent resistance to atmospheric agents. All these materials are recyclable in the full respect of our Natural Environment. Gaber produces plastic injected materials without added chemicals and, as far as possible, recycled pre-used technopolymers are sourced as a base raw material. Technopolymer table top colors perfectly match the colors of Gaber's seating collection.

MAINTENANCE & CLEANING

The plastic surfaces of Gaber products can generally be cleaned with a cloth and warm water. For the most persistent stains, a small amount of liquid soap diluted in water may be used. Do not use acetone, trichloroethylene, ammonia, alcoholic substances and detergents that contain even just a small amount of these substances. We also recommend avoiding all types of abrasive and solvent substances or rough sponges.

COME SONO FATTI I RIPIANI IN TECNOPOLIMERO?

I piani in Tecnopolimero utilizzati da Gaber per i propri tavoli sono realizzati per mezzo del processo di iniezione plastica. I piani così realizzati sono pratici, resistenti agli urti, colorati ed economici. I compound di tecnopolimeri utilizzati da Gaber nella realizzazione dei propri prodotti sono caratterizzati da un'elevata resistenza strutturale, termica e all'abrasione. Il tecnopolimero è atossico, antimacchia, antistatico e anti-uv: qualità che lo rendono ottimamente resistente agli agenti atmosferici. I tecnopolimeri utilizzati da Gaber sono integralmente riciclabili, nel pieno rispetto del nostro Ambiente Naturale. Gaber produce articoli termoplastici senza additivi chimici e, ove possibile, vengono utilizzati tecnopolimeri riciclati derivanti da post-consumo. I colori dei ripiani dei tavoli corrispondono ai colori della vasta collezione di sedute Gaber.

MANUTENZIONE E PULIZIA

Le superfici in tecno polimero dei piani dei tavoli Gaber possono essere pulite con un panno umido e soffice imbevuto in acqua. Per le macchie più ostinate è possibile diluire in acqua del sapone neutro liquido con moderazione. Non utilizzare acetone, trielina, ammoniacca, sostanze alcoliche o detersivi che contengano anche piccole quantità di tali detersivi. Non utilizzare a contatto con il prodotto sostanze abrasive o solventi, strumenti di pulizia ruvidi.

LAMINATED SURFACES



22 mm
(0.86")





F

W

RN

00

10

	Sizes / Misure	Code / Codice	
	Ø 60 (23 ½")	PTL101._	0.054m³ / 11kg / 2pcs
	Ø 70 (27 ½")	PTL103._	0.074m³ / 13kg / 2pcs
	60x60 (23 ½"X23 ½")	PTL102._	0.054m³ / 13kg / 2pcs
	70x70 (27 ½"X27 ½")	PTL104._	0.074m³ / 19kg / 2pcs
	80x80 (31 ½"X31 ½")	PTL106._	0.090m³ / 24kg / 2pcs
	90x90 (35 ½"X35 ½")	PTL107._	0.11m³ / 27kg / 2pcs
	120x50 (47"X19 ½")	PTL110._	0.11m³ / 27kg / 2pcs
	120x80 (47"X31 ½")	PTL112._	0.20m³ / 30kg / 2pcs
	140x70 (55"X27 ½")	PTL111._	0.20m³ / 34kg / 2pcs

ABOUT LAMINATED TABLE TOPS

Gaber's laminate table tops are composed of a high-pressure decorative laminate layer, with a recycled-wood chipboard core and ABS edging. Gaber's support materials are E1 according to tests stipulated by the European standards EN717 and EN120 regarding formaldehyde emission. Laminate tops come ready for Gaber kit bases. The result is homogeneous, static, lightweight and highly customizable in terms of shapes and finishes.

MAINTENANCE & CLEANING

Gaber laminated table tops do not require any special maintenance beyond normal cleaning.

Laminated surfaces can be easily cleaned with a soft cloth dampened with water, even with cleaning agents, but not alkaline and generally aggressive. Avoid the use of strong acids or bases, avoid wiping with abrasive substances or equipment.

COSA SONO I PIANI DEI TAVOLI IN LAMINATO?

I ripiani laminati che Gaber utilizza per i propri tavoli sono composti da uno strato di laminato decorativo ad alta pressione, supportato da un pannello di truciolare; quest'ultimo realizzato con i materiali di scarto delle normali lavorazioni del legno. I piani sono bordati con bordo in Abs. La tipologia di supporto utilizzato da Gaber per i propri piani è di classe E1 secondo i test espressi dalle normative europee EN717 e EN120 in materia di emissione di formaldeide. I fissaggi dei ripiani in Laminato sono già predisposti per i basamenti Gaber.

Il risultato è un prodotto omogeneo, antistatico, leggero e facilmente personalizzabile in forme e finiture.

MANUTENZIONE E PULIZIA

I piani Laminati di Gaber non richiedono alcuna manutenzione particolare al di là della normale pulizia.

La sua superficie può essere facilmente pulita con un panno morbido imbevuto di acqua, anche con detersivi per uso domestico, purché non alcalini ed in genere aggressivi. Evitare l'uso di acidi o basi forti, evitare di strofinare con sostanze o strumenti abrasivi.



LAMINATED SURFACES

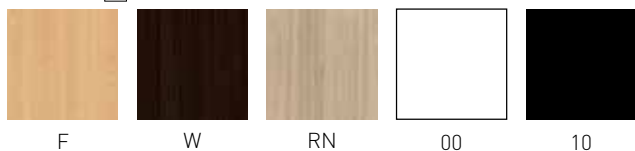

50 mm
(1.96")

42 mm 20 mm



	Sizes / Misure	Code / Codice	
	60x60 (23 1/2"X23 1/2")	PTL202._	0.054m ³ / 7kg / 1pcs
	70x70 (27 1/2"X27 1/2")	PTL204._	0.074m ³ / 9kg / 1pcs
	80x80 (31 1/2"X31 1/2")	PTL206._	0.090m ³ / 13kg / 1pcs
	90x90 (35 1/2"X35 1/2")	PTL207._	0.11m ³ / 15kg / 1pcs
	120x80 (47"X31 1/2")	PTL212._	0.20m ³ / 17kg / 1pcs

ABOUT LAMINATED TABLE TOPS

Gaber's laminate table tops are composed of a high-pressure decorative laminate layer, with a recycled-wood chipboard core and ABS edging. Gaber's support materials are E1 according to tests stipulated by the European standards EN717 and EN120 regarding formaldehyde emission. Laminate tops come ready for Gaber kit bases.

The result is homogeneous, static, lightweight and highly customizable in terms of shapes and finishes.

MAINTENANCE & CLEANING

Gaber laminated table tops do not require any special maintenance beyond normal cleaning.

Laminated surfaces can be easily cleaned with a soft cloth dampened with water, even with cleaning agents, but not alkaline and generally aggressive. Avoid the use of strong acids or bases, avoid wiping with abrasive substances or equipment.

COSA SONO I PIANI DEI TAVOLI IN LAMINATO?

I ripiani laminati che Gaber utilizza per i propri tavoli sono composti da uno strato di laminato decorativo ad alta pressione, supportato da un pannello di truciolare; quest'ultimo realizzato con i materiali di scarto delle normali lavorazioni del legno. I piani sono bordati con bordo in Abs. La tipologia di supporto utilizzato da Gaber per i propri piani è di classe E1 secondo i test espressi dalle normative europee EN717 e EN120 in materia di emissione di formaldeide. I fissaggi dei ripiani in Laminato sono già predisposti per i basamenti Gaber.

Il risultato è un prodotto omogeneo, antistatico, leggero e facilmente personalizzabile in forme e finiture.

MANUTENZIONE E PULIZIA

I piani Laminati di Gaber non richiedono alcuna manutenzione particolare al di là della normale pulizia.

La sua superficie può essere facilmente pulita con un panno morbido imbevuto di acqua, anche con detersivi per uso domestico, purché non alcalini ed in genere aggressivi. Evitare l'uso di acidi o basi forti, evitare di strofinare con sostanze o strumenti abrasivi.

LEATHER SURFACES

ABOUT LEATHER TABLE TOPS

Gaber's leather table tops are made of an extremely stable composite material support, covered with high quality leather. The result is an elegant and refined surface.

MAINTENANCE & CLEANING

Leather is an extremely delicate material and great care needs to be taken in use. Leather surfaces need to be cleaned with a soft white cloth, and water. If necessary, use high quality products and to follow carefully the instructions of the manufacturer. If it doubt, we suggest you apply any cleaning product to a hidden area of leather and leave for 24 hours to be able to assess any side-effects.

COME SONO REALIZZATI I PIANI IN PELLE?

I piani in Pelle che Gaber utilizza per i propri tavoli sono composti da un supporto di materiale composito estremamente stabile, rivestito con pelli di assoluta qualità. Il risultato è un prodotto elegante e raffinato.

MANUTENZIONE E PULIZIA

La pelle è un materiale delicato, pertanto è consigliato prestare cura durante l'utilizzo. I ripiani in Pelle possono essere puliti con un panno bianco umido imbevuto di sola acqua. In caso, utilizzare prodotti di qualità per la pulizia della pelle, seguendo attentamente le indicazioni del fabbricante del prodotto di pulizia. Nel dubbio testare il prodotto su di una parte nascosta e attendere almeno 24 ore per l'eventuale insorgenza di problemi.



TABLE BASES COLLECTION

COLLEZIONE BASAMENTI



BG3K

H73 3-spur metal-technopolymer co-injected table base, Ø 80mm anodized aluminum column with cross.

Base per tavolo H73 a tre razze in metallo sovrastampato con tecnopolimero, colonna in alluminio anodizzato Ø 80mm, crociera.

Top max dimensions / Massima dimensione piano

Available table tops / Piani tavolo disponibili

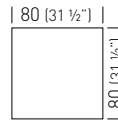

compactop
laminated
iron

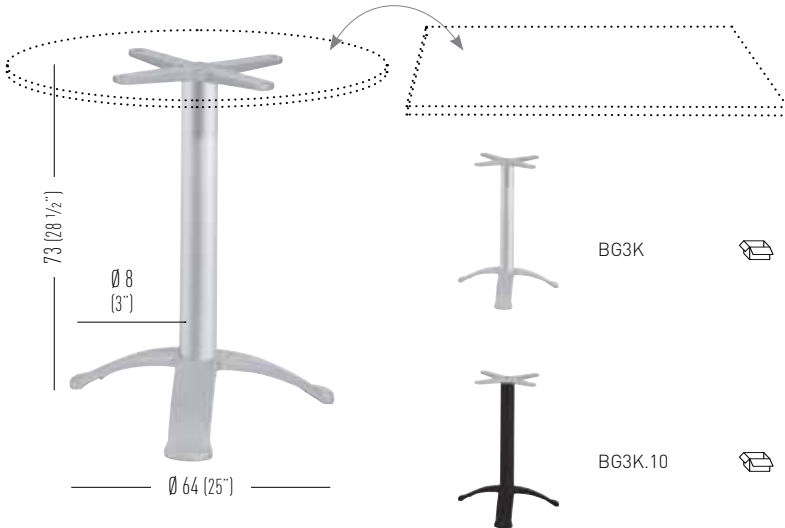

BG3K 0.07m³ / 19.6kg / 2pcs

BG3K.10 0.07m³ / 19.6kg / 2pcs

BGA3K

H110 3-spur metal-technopolymer co-injected table base, Ø 80mm anodized aluminum column with cross.

Base per tavolo H110 a tre razze in metallo sovrastampato con tecnopolimero, colonna in alluminio anodizzato Ø 80mm, crociera.

Top max dimensions / Massima dimensione piano

Available table tops / Piani tavolo disponibili

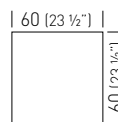
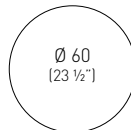

compactop
laminated
iron

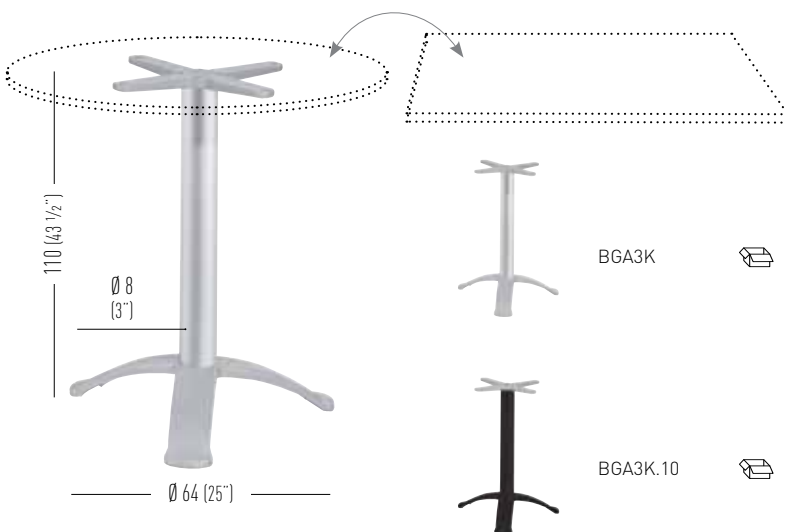

BGA3K 0.12m³ / 21.6kg / 2pcs

BGA3K.10 0.12m³ / 21.6kg / 2pcs



BPG3K

H73 3-spur metal-technopolymer co-injected table base, Ø 60mm anodized aluminum column with cross.

Base per tavolo H73 a tre razze in metallo sovrastampato con tecnopolimero, colonna in alluminio anodizzato Ø 60mm, crociera.

Top max dimensions / Massima dimensione piano

Available table tops / Piani tavolo disponibili

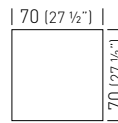
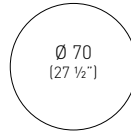

compactop
laminated
iron

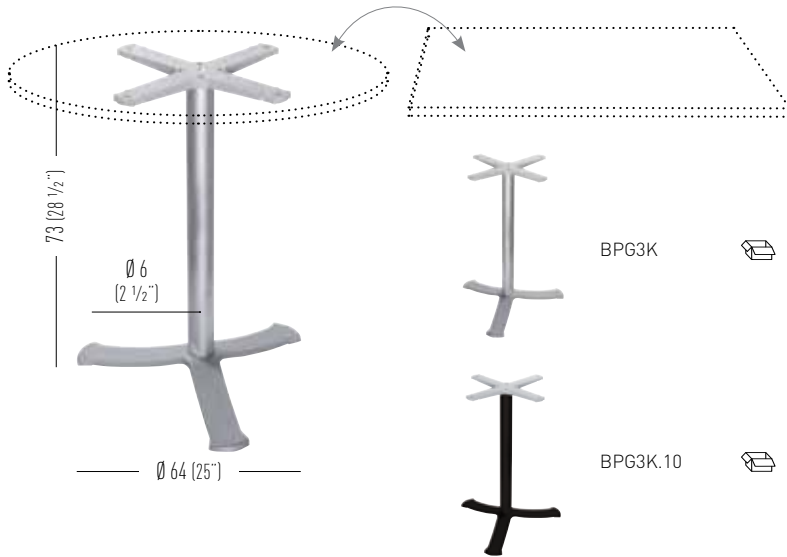

BPG3K 0.07m³ / 14.20kg / 2pcs

BPG3K.10 0.07m³ / 14.20kg / 2pcs



BG3L

H73 3-spur metal-technopolymer co-injected table base, Ø 80mm anodized aluminum column with cross.

Base per tavolo H73 a tre razze in metallo sovrastampato con tecnopolimero, colonna in alluminio anodizzato Ø 80mm, crociera.

Top max dimensions / Massima dimensione piano

Available table tops / Piani tavolo disponibili

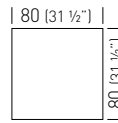
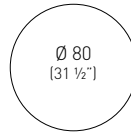

compactop
laminated
iron

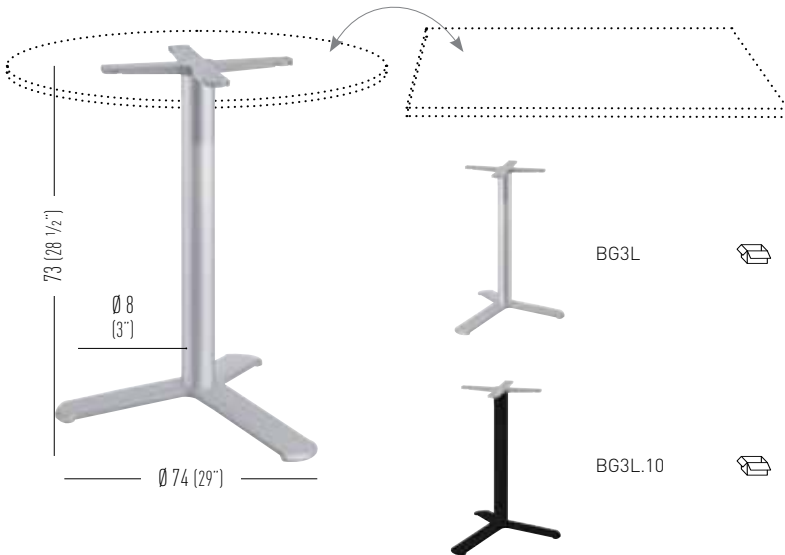

BG3L 0.08m³ / 11kg / 1pcs

BG3L.10 0.08m³ / 11kg / 1pcs

BGA3L

H110 3-spur metal-technopolymer co-injected table base, Ø 80mm anodized aluminum column with cross.

Base per tavolo H110 a tre razze in metallo sovrastampato con tecnopolimero, colonna in alluminio anodizzato Ø 80mm, crociera.

Top max dimensions / Massima dimensione piano

Available table tops / Piani tavolo disponibili

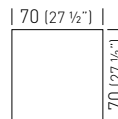
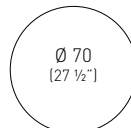

compactop
laminated
iron

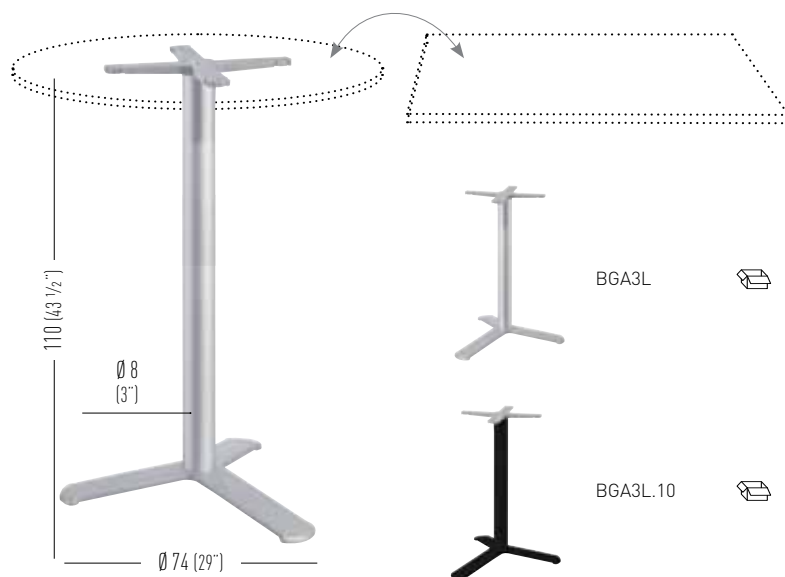

BGA3L 0.12m³ / 23.6kg / 2pcs

BGA3L.10 0.12m³ / 23.6kg / 2pcs



BG4K

H73 4-spur metal-technopolymer co-injected table base, Ø 80mm anodized aluminum column with cross.

Base per tavolo H73 a quattro razze in metallo sovrastampato con tecnopolimero, colonna in alluminio anodizzato Ø 80mm, crociera.



Top max dimensions / Massima dimensione piano

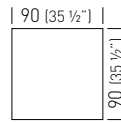
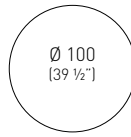

Available table tops / Piani tavolo disponibili

compactop
laminated
iron

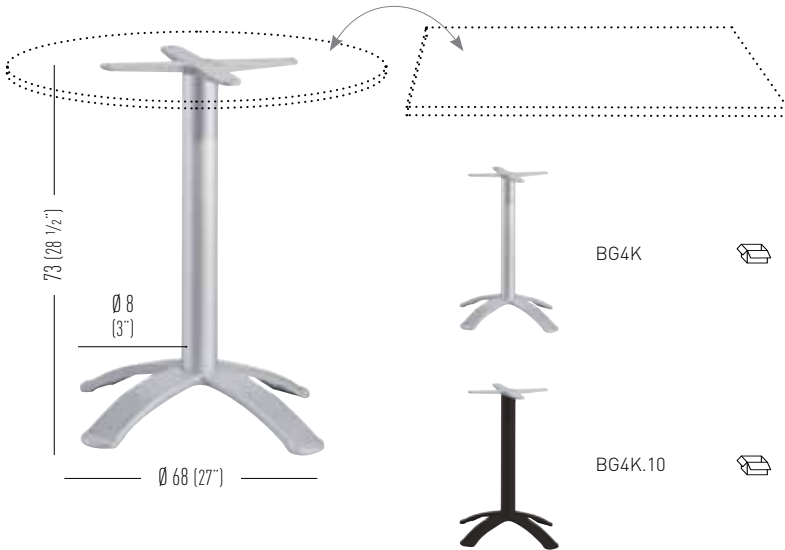

BG4K 0.07m³ / 25kg / 2pcs

BG4K.10 0.07m³ / 25kg / 2pcs

BG4J

H73 4-spur metal-technopolymer co-injected table base, 80x80mm anodized aluminum column with cross.

Base per tavolo H73 a quattro razze in metallo sovrastampato con tecnopolimero, colonna in alluminio anodizzato 80x80mm, crociera



Top max dimensions / Massima dimensione piano

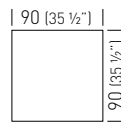
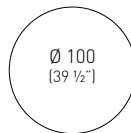

Available table tops / Piani tavolo disponibili

compactop
laminated
iron

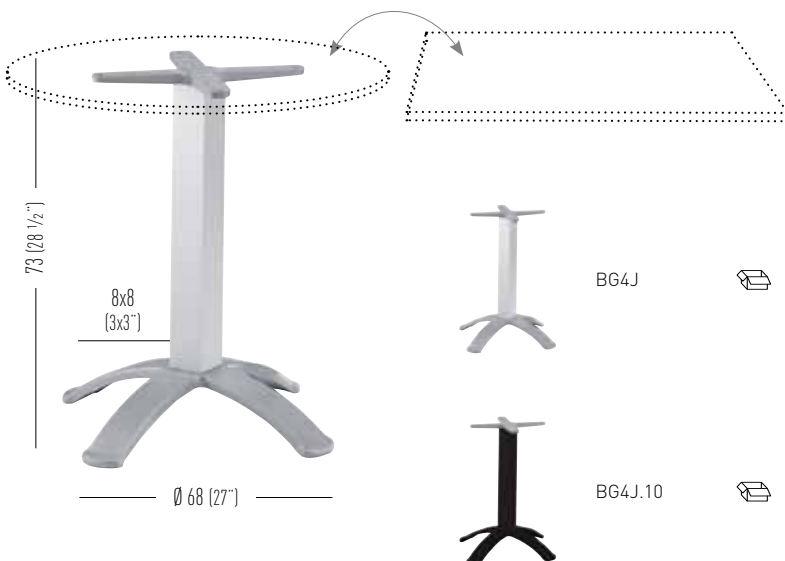

BG4J 0.10m³ / 25.6kg / 2pcs

BG4J.10 0.10m³ / 25.6kg / 2pcs

BGPK

H73 4-spur metal-technopolymer co-injected table base, Ø 80mm anodized aluminum column with flip-top mechanism.
Base per tavolo pieghevole H73 a quattro razze in metallo sovrastampato con tecnopolimero, colonna in alluminio anodizzato Ø 80mm.

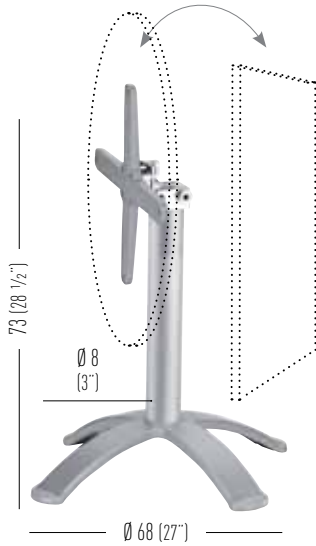

Top max dimensions / Massima dimensione piano

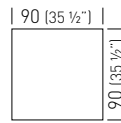
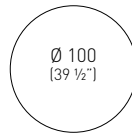

Available table tops / Piani tavolo disponibili

compactop
laminated
iron



BGPK

0.07m³ / 27kg / 2pcs



BGPK.10

0.07m³ / 27kg / 2pcs

BGPJ

H73 4-spur metal-technopolymer co-injected table base, 80x80mm anodized aluminum column with flip-top mechanism.
Base per tavolo pieghevole H73 a quattro razze in metallo sovrastampato con tecnopolimero, colonna in alluminio anodizzato 80x80mm.

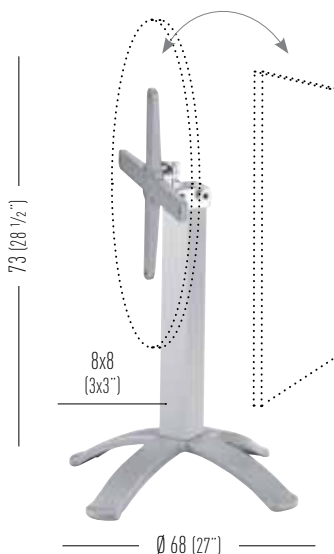

Top max dimensions / Massima dimensione piano

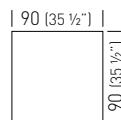
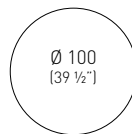

Available table tops / Piani tavolo disponibili

compactop
laminated
iron



BGPJ

0.10m³ / 27.60kg / 2pcs



BGPJ.10

0.10m³ / 27.60kg / 2pcs

BGA4K

H115 4-spur metal-technopolymer co-injected table base, Ø 80mm anodized aluminum column with cross.

Base per tavolo H115 a quattro razze in metallo sovrastampato con tecnopolimero, colonna in alluminio anodizzato Ø 80mm, crociera.

Top max dimensions / Massima dimensione piano

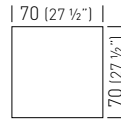
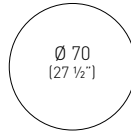

Available table tops / Piani tavolo disponibili

compactop
laminated
iron

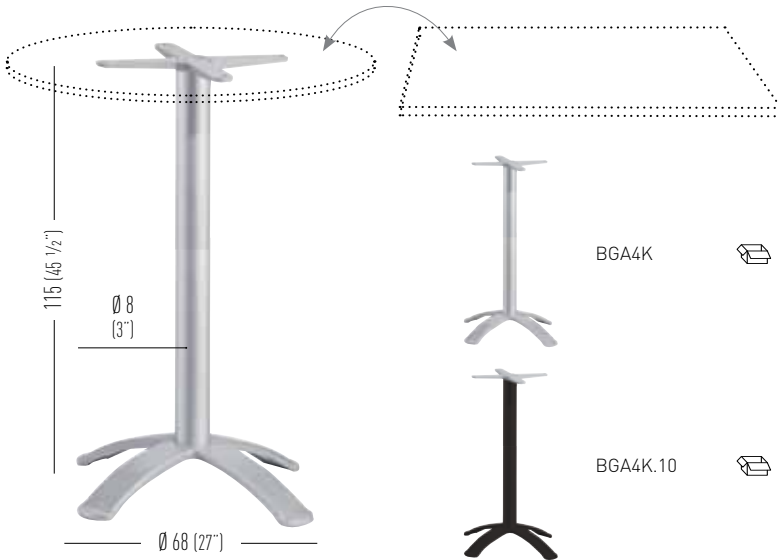

BGA4K  0.11m³ / 26.60kg / 2pcs

BGA4K.10  0.11m³ / 26.60kg / 2pcs



BPG4K

H73 4-spur metal-technopolymer co-injected table base, Ø 60mm anodized aluminum column with cross.
 Base per tavolo H73 a quattro razze in metallo sovrastampato con tecnopolimero, colonna in alluminio anodizzato Ø 60mm, crociera.

Top max dimensions / Massima dimensione piano

Available table tops / Piani tavolo disponibili

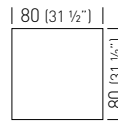
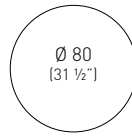

compactop
laminated
iron

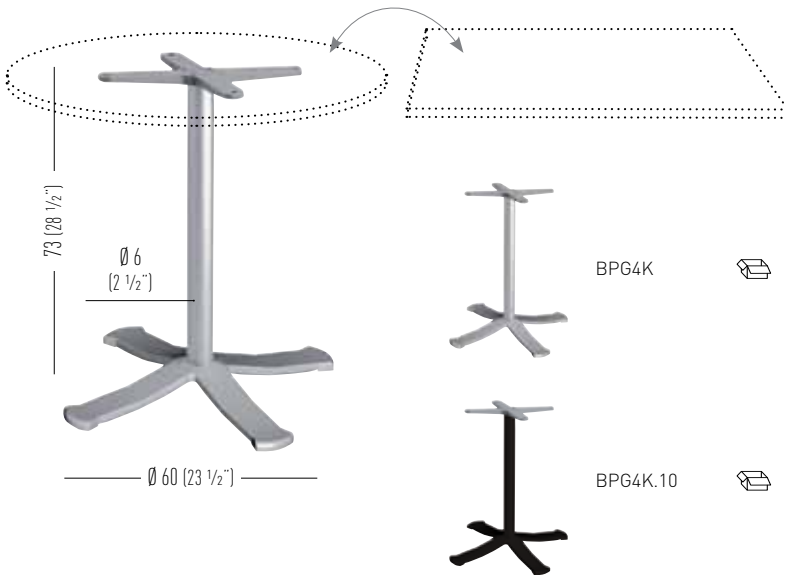

BPG4K 0.07m³ / 17kg / 2pcs

BPG4K.10 0.07m³ / 17kg / 2pcs



BG4IP

H73 stacking 4-spur metal-technopolymer co-injected table base, Ø 80mm round anodized aluminum column with flip-top mechanism. Adjustable feet.

Base per tavolo pieghevole e accatastabile H73 a quattro razze in metallo sovrastampato con tecnopolimero, colonna in alluminio anodizzato Ø 80mm. Piedini regolabili.

Top max dimensions / Massima dimensione piano

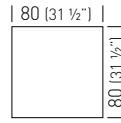

Available table tops / Piani tavolo disponibili

compactop
laminated
iron

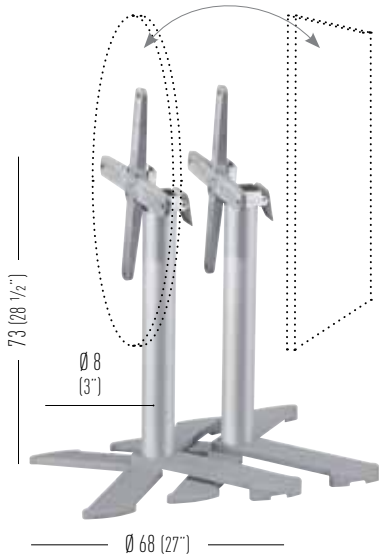

BG4IP

0.07m³ / 20kg / 2pcs



BG4IP.10

0.07m³ / 20kg / 2pcs



BG2J

H73 double metal-technopolymer co-injected table base,
80x80mm anodized aluminum column with cross.
Base doppia per tavolo H73 in metallo sovrastampato con
tecnopolimero, colonna in alluminio anodizzato 80x80mm, crociera.



Top max dimensions / Massima dimensione piano

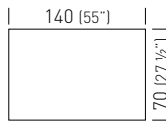

Available table tops / Piani tavolo disponibili

compactop
laminated
iron

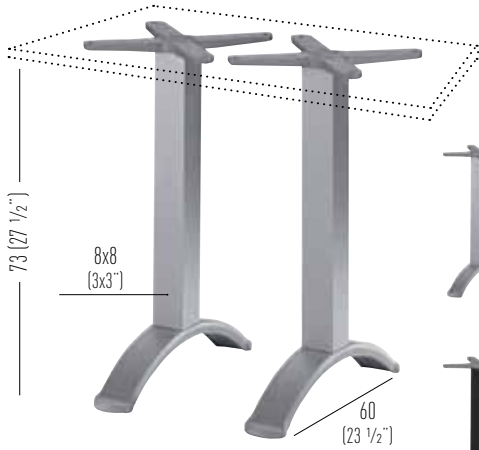

BG2J

0.07m³ / 30kg / 2pcs



BG2J.10

0.07m³ / 30kg / 2pcs



BTK

H73 round metal-technopolymer co-injected table base, Ø 80mm anodized aluminum column with cross.

Base per tavolo H73 rotonda in metallo sovrastampato con tecnopolimero, colonna in alluminio anodizzato Ø 80mm, crociera.



Top max dimensions / Massima dimensione piano

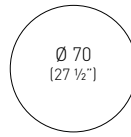

Available table tops / Piani tavolo disponibili

compactop
laminated
iron

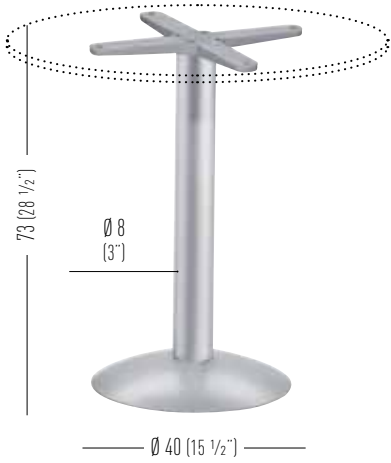

BTK

0.10m³ / 19.60kg / 2pcs



BTK.10

0.10m³ / 19.60kg / 2pcs

BTAK

H110 round metal-technopolymer co-injected table base, Ø 80mm anodized aluminum column with cross.

Base per tavolo H110 rotonda in metallo sovrastampato con tecnopolimero, colonna in alluminio anodizzato Ø 80mm, crociera.



Top max dimensions / Massima dimensione piano

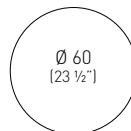

Available table tops / Piani tavolo disponibili

compactop
laminated
iron

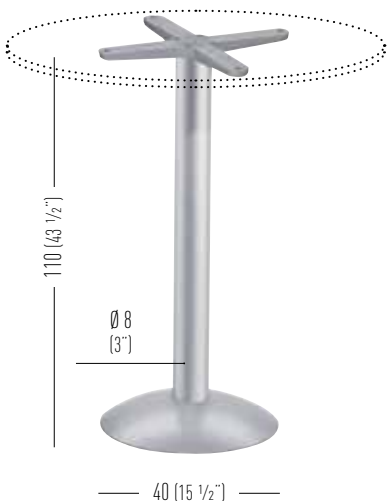

BTAK

0.11m³ / 21.60kg / 2pcs



BTAK.10

0.11m³ / 21.60kg / 2pcs



BTK54

H73 round metal-technopolymer co-injected table base, Ø 80mm anodized aluminum column with cross.

Base per tavolo H73 rotonda in metallo sovrastampato con tecnopolimero, colonna in alluminio anodizzato Ø 80mm, crociera.



Top max dimensions / Massima dimensione piano

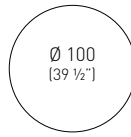

Available table tops / Piani tavolo disponibili

compactop
laminated
iron

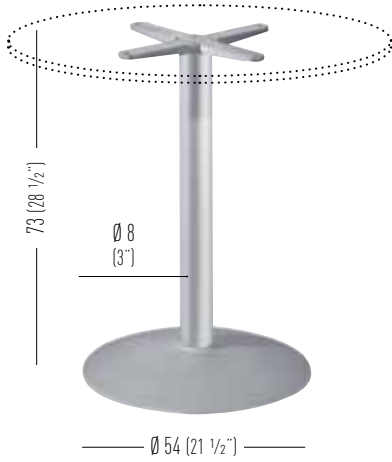

BTK54 0.10m³ / 24.60kg / 2pcs



BTK54.10 0.10m³ / 24.60kg / 2pcs

BTAK54

H110 round metal-technopolymer co-injected table base, Ø 80mm anodized aluminum column with cross.

Base per tavolo H110 rotonda in metallo sovrastampato con tecnopolimero, colonna in alluminio anodizzato Ø 80mm, crociera.



Top max dimensions / Massima dimensione piano

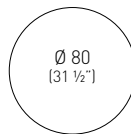

Available table tops / Piani tavolo disponibili

compactop
laminated
iron

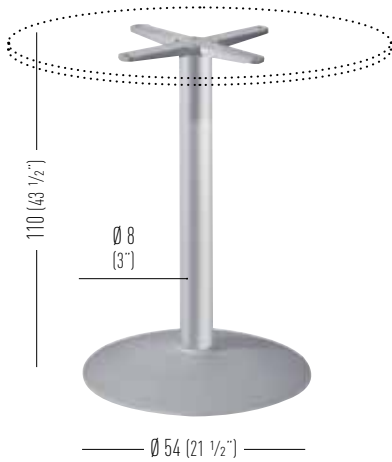

BTAK54 0.11m³ / 25.60kg / 2pcs



BTAK54.10 0.11m³ / 25.60kg / 2pcs



BRCV

H73 round metal-technopolymer co-injected table base, Ø 50mm
 anodized aluminum column with cross.
 Base per tavolo H73 rotonda in metallo sovrastampato con
 tecnopolimero, colonna in alluminio anodizzato Ø 50mm, crociera.



Top max dimensions / Massima dimensione piano

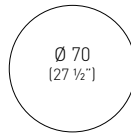

Available table tops / Piani tavolo disponibili

compactop
 laminated
 iron

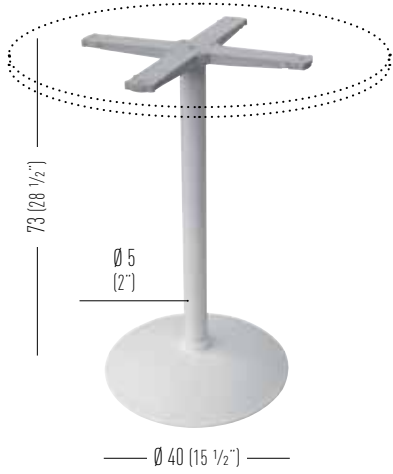

BRCV

0.07m³ / 15kg / 2pcs



BRCV.10

0.07m³ / 15kg / 2pcs



VENUS ROUND

H73 metal-technopolymer co-injected table base.
Base per tavolo H73 rotonda in metallo sovrastampato con tecnopolimero.

Additional weight on request (+3).
Peso supplementare disponibile su richiesta (+3).

Top max dimensions / Massima dimensione piano

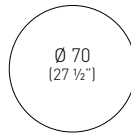

Available table tops / Piani tavolo disponibili



compactop
laminated
iron





BGVR.00
BGVR.00+3

 0.2m³ / 6kg / 1pcs
 0.2m³ / 9kg / 1pcs





BGVR.14
BGVR.14+3

 0.2m³ / 6kg / 1pcs
 0.2m³ / 9kg / 1pcs



BGVR.10
BGVR.10+3

 0.2m³ / 6kg / 1pcs
 0.2m³ / 9kg / 1pcs



VENUS SQUARE

H73 metal-technopolymer co-injected table base.
Base per tavolo H73 quadrata in metallo sovrastampato con tecnopolimero.

Top max dimensions / Massima dimensione piano

Available table tops / Piani tavolo disponibili

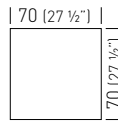

compactop
laminated
iron

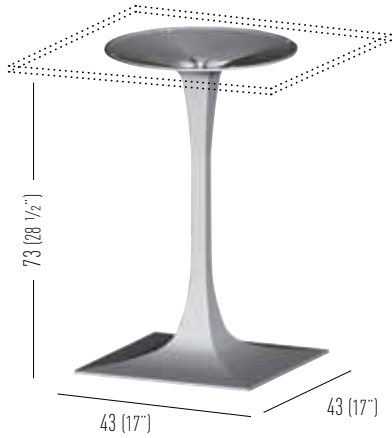

BGVQ.00

0.2m³ / 7kg / 1pcs



BGVQ.14

0.2m³ / 7kg / 1pcs



BGVQ.10

0.2m³ / 7kg / 1pcs



BRK

H73 round metal-technopolymer co-injected table base, Ø 80mm anodized aluminum column with cross.

Base per tavolo H73 rotonda in metallo sovrastampato con tecnopolimero, colonna in alluminio anodizzato Ø 80mm, crociera.



Top max dimensions / Massima dimensione piano

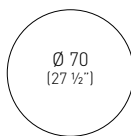

Available table tops / Piani tavolo disponibili

compactop
laminated
iron

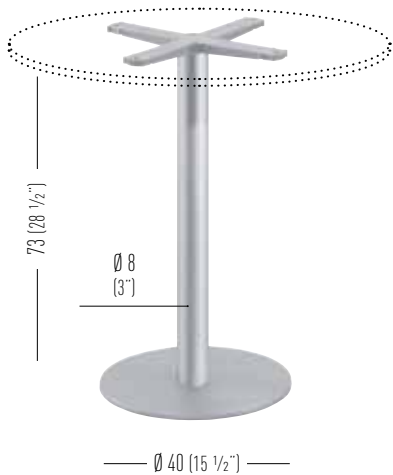

BRK

0.07m³ / 20.60kg / 2pcs

BRK.10

0.07m³ / 20.60kg / 2pcs



BQJ

H73 square metal-technopolymer co-injected table base, 80x80mm anodized aluminum column with cross.

Base per tavolo H73 quadrata in metallo sovrastampato con tecnopolimero, colonna in alluminio anodizzato 80x80mm, crociera.



Top max dimensions / Massima dimensione piano

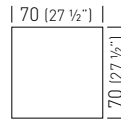

Available table tops / Piani tavolo disponibili

compactop
laminated
iron



BQJ

0.07m³ / 24.60kg / 2pcs



BQJ.10

0.07m³ / 24.60kg / 2pcs

BQAJ

H103 square metal-technopolymer co-injected table base, 80x80mm square anodized aluminum column with cross.

Base per tavolo H103 quadrata in metallo sovrastampato con tecnopolimero, colonna quadrata in alluminio anodizzato 80x80mm, crociera.



Top max dimensions / Massima dimensione piano

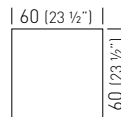

Available table tops / Piani tavolo disponibili

compactop
laminated
iron



BQAJ

0.08m³ / 25.60kg / 2pcs



BQAJ.10

0.08m³ / 24.60kg / 2pcs

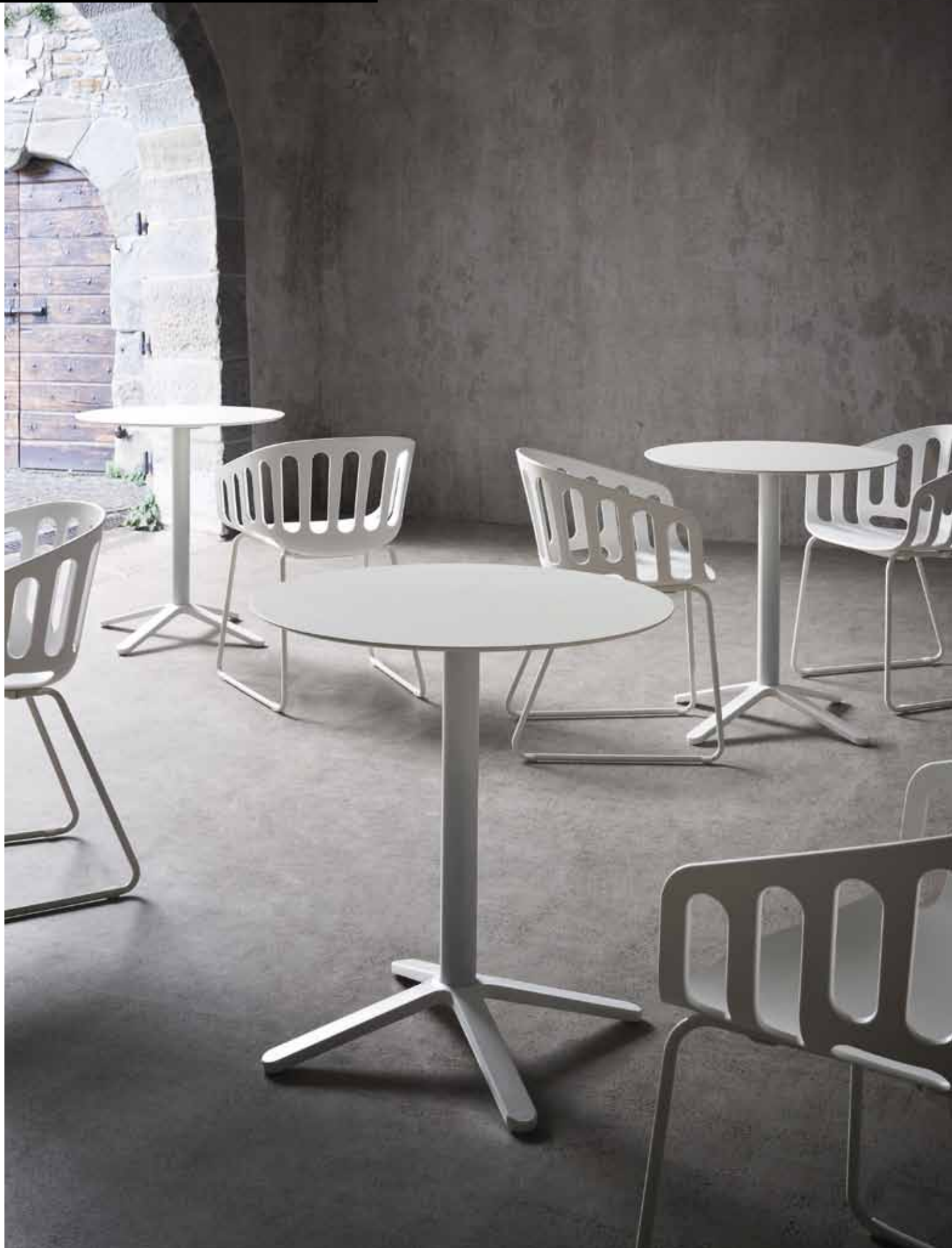

LEI

H73 or H110 4-spur metal-technopolymer co-injected table base, Ø 60mm anodized aluminum column with cross.
 Base per tavolo H73 o H110 a quattro razze in metallo sovrastampato con tecnopolimero, colonna in alluminio anodizzato Ø 60mm, crociera.



Top max dimensions / Massima dimensione piano

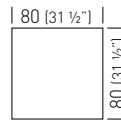
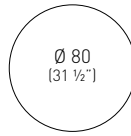

Only H110 / Solo H110

Available table tops / Piani tavolo disponibili

compactop
laminated
iron

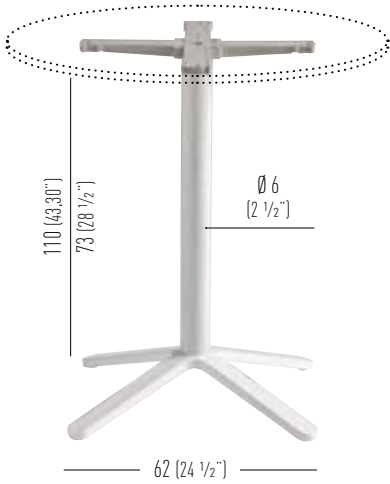

BLEI.00 0.07m³ / 8.5kg / 1pcs
 BLEIA.00 0.09m³ / 9kg / 1pcs



BLEI.10 0.07m³ / 8.5kg / 1pcs
 BLEIA.10 0.09m³ / 9kg / 1pcs



AMICA

H73 4-spur table base collection made of die-cast painted aluminum, Ø60mm metal painted column with cross.
 Collezione basamenti per tavoli H73 a quattro razze in alluminio pressofuso verniciato, colonna in metallo verniciato Ø60mm, crociera.



BDA1.00

0.07m³ / 6.5kg / 1pcs



BDA1.10

0.07m³ / 6.5kg / 1pcs

ADJUSTABLE FEET
 PIEDINI REGOLABILI

Available table tops / Piani tavolo disponibili

compactop
 laminated
 iron

Top max dimensions / Massima dimensione piano

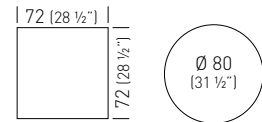

BDA2.00

0.07m³ / 7kg / 1pcs



BDA2.10

0.07m³ / 7kg / 1pcs

ADJUSTABLE FEET
 PIEDINI REGOLABILI

Top max dimensions / Massima dimensione piano

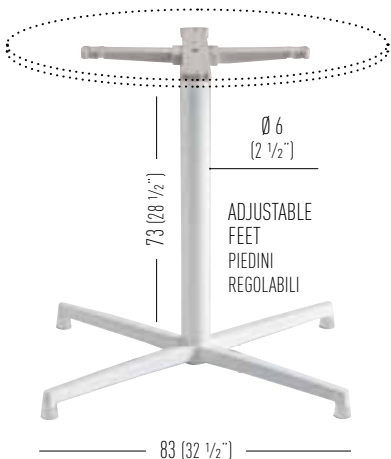
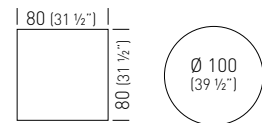

BDA3.00

0.08m³ / 8kg / 1pcs



BDA3.10

0.08m³ / 8kg / 1pcs

ADJUSTABLE FEET
 PIEDINI REGOLABILI

Top max dimensions / Massima dimensione piano

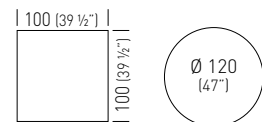



R1

H74-H110 round steel table base, Ø 60mm steel column with cross.

Base per tavolo rotonda in acciaio H74 e H110, colonna in acciaio Ø 60mm, crociera.

Top max dimensions / Massima dimensione piano

Available table tops / Piani tavolo disponibili

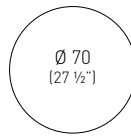

compactop
laminated
iron



Finishes for R bases / Finiture per basamenti serie R

Polished Steel-Chromed Column / Acciaio Lucido-Colonna Cromata

	H74	BAR1.A	0.07m ³ / 15kg / 1pcs
	H110	BAR1A.A	0.09m ³ / 17kg / 1pcs

Satin Steel-Satin Column / Acciaio Satinato-Colonna Satinata

	H74	BAR1.S	0.07m ³ / 15kg / 1pcs
	H110	BAR1A.S	0.09m ³ / 17kg / 1pcs

White Painted / Verniciata Bianca

	H74	BAR1.00	0.07m ³ / 15kg / 1pcs
	H110	BAR1A.00	0.09m ³ / 17kg / 1pcs

Black Painted / Verniciata Nera

	H74	BAR1.10	0.07m ³ / 15kg / 1pcs
	H110	BAR1A.10	0.09m ³ / 17kg / 1pcs

R2

H74-H110 round steel table base, Ø 60mm steel column with cross.

Base per tavolo rotonda in acciaio H74 e H110, colonna in acciaio Ø 60mm, crociera.

Top max dimensions / Massima dimensione piano

Available table tops / Piani tavolo disponibili

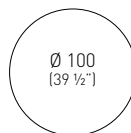

compactop
laminated
iron



Finishes for R bases / Finiture per basamenti serie R

Polished Steel-Chromed Column / Acciaio Lucido-Colonna Cromata

	H74	BAR2.A	0.07m ³ / 18kg / 1pcs
	H110	BAR2A.A	0.09m ³ / 20kg / 1pcs

Satin Steel-Satin Column / Acciaio Satinato-Colonna Satinata

	H74	BAR2.S	0.07m ³ / 18kg / 1pcs
	H110	BAR2A.S	0.09m ³ / 20kg / 1pcs

White Painted / Verniciata Bianca

	H74	BAR2.00	0.07m ³ / 18kg / 1pcs
	H110	BAR2A.00	0.09m ³ / 20kg / 1pcs

Black Painted / Verniciata Nera

	H74	BAR2.10	0.07m ³ / 18kg / 1pcs
	H110	BAR2A.10	0.09m ³ / 20kg / 1pcs

BASES FOR INDOOR

R3

H74-H110 round steel table base, Ø 80mm round steel column with cross.

Base per tavolo rotonda in acciaio H74 e H110, colonna rotonda in acciaio Ø 80mm, crociera.

Top max dimensions / Massima dimensione piano

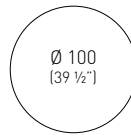

Available table tops / Piani tavolo disponibili

compactop
laminated
iron



Finishes for R bases / Finiture per basamenti serie R

Polished Steel-Chromed Column / Acciaio Lucido-Colonna Cromata



H74	BAR3.A	0.07m³ / 21kg / 1pcs
H110	BAR3A.A	0.09m³ / 23kg / 1pcs

Satin Steel-Satin Column / Acciaio Satinato-Colonna Satinata



H74	BAR3.S	0.07m³ / 21kg / 1pcs
H110	BAR3A.S	0.09m³ / 23kg / 1pcs

White Painted / Verniciata Bianca



H74	BAR3.00	0.07m³ / 21kg / 1pcs
H110	BAR3A.00	0.09m³ / 23kg / 1pcs

Black Painted / Verniciata Nera



H74	BAR3.10	0.07m³ / 21kg / 1pcs
H110	BAR3A.10	0.09m³ / 23kg / 1pcs

V1

H73 round chromed metal table base, Ø 50mm chromed metal column with cross.

Base per tavolo H73 rotonda in metallo cromato, colonna in metallo cromato Ø 50mm, crociera.

Top max dimensions / Massima dimensione piano

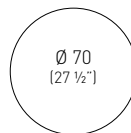

Available table tops / Piani tavolo disponibili

compactop
laminated
iron

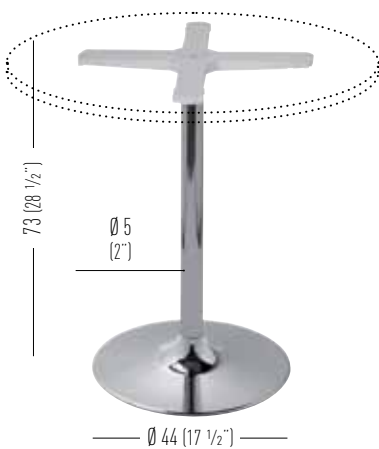

Finishes for V1 bases / Finiture per basamenti serie V1

Polished Steel-Chromed Column / Acciaio Lucido-Colonna Cromata



H73	BV1C	0.1m³ / 15.6kg / 2 pcs
-----	------	------------------------

T1 FLOOR FIXING

Floor Fixing H74 round steel table base, Ø 80mm round steel column with cross.

Base per tavolo H74 rotonda in metallo per fissaggio a terra, colonna rotonda in metallo Ø 80mm, crociera.

Top max dimensions / Massima dimensione piano

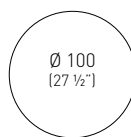

Available table tops / Piani tavolo disponibili

compactop
laminated
iron



Finishes for T1 bases / Finiture per basamenti serie T1

Polished Steel-Chromed Column / Acciaio Lucido-Colonna Cromata



H74

BAT1.S



0.05m³ / 11kg / 1pcs



Q1

H74-H110 square steel table base, 60x60mm steel column with cross.

Base per tavolo quadrata in acciaio H74 e H110, colonna in acciaio 60x60mm, crociera.

Top max dimensions / Massima dimensione piano

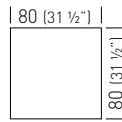

Available table tops / Piani tavolo disponibili

compactop
laminated
iron

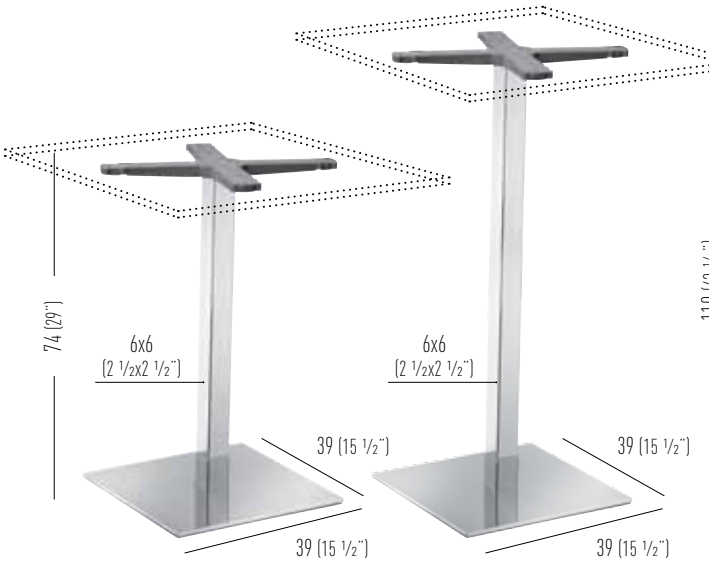

Finishes for Q bases / Finiture per basamenti serie Q

Polished Steel-Chromed Column / Acciaio Lucido-Colonna Cromata



H74	BAQ1.A	0.07m ³ / 17kg / 1pcs
H110	BAQ1A.A	0.09m ³ / 19kg / 1pcs

Satin Steel-Satin Column / Acciaio Satinato-Colonna Satinata



H74	BAQ1.S	0.07m ³ / 17kg / 1pcs
H110	BAQ1A.S	0.09m ³ / 19kg / 1pcs

White Painted / Verniciata Bianca



H74	BAQ1.00	0.07m ³ / 17kg / 1pcs
H110	BAQ1A.00	0.09m ³ / 19kg / 1pcs

Black Painted / Verniciata Nera



H74	BAQ1.10	0.07m ³ / 17kg / 1pcs
H110	BAQ1A.10	0.09m ³ / 19kg / 1pcs



Q2

H74-H110 square steel table base, 60x60mm steel column with cross.

Base per tavolo quadrata in acciaio H74 e H110, colonna in acciaio 60x60mm, crociera.

Top max dimensions / Massima dimensione piano

Available table tops / Piani tavolo disponibili

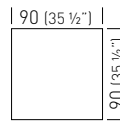

compactop
laminated
iron

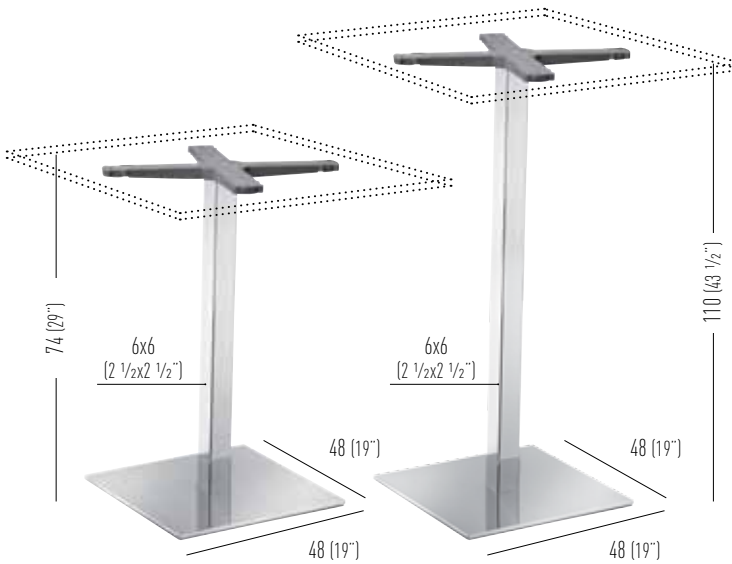

Finishes for Q bases / Finiture per basamenti serie Q

Polished Steel-Chromed Column / Acciaio Lucido-Colonna Cromata

	H74	BAQ2.A		0.07m ³ / 18kg / 1pcs
	H110	BAQ2.A.A		0.09m ³ / 20kg / 1pcs

Satin Steel-Satin Column / Acciaio Satinato-Colonna Satinata

	H74	BAQ2.S		0.07m ³ / 18kg / 1pcs
	H110	BAQ2.A.S		0.09m ³ / 20kg / 1pcs

White Painted / Verniciata Bianca

	H74	BAQ2.00		0.07m ³ / 18kg / 1pcs
	H110	BAQ2A.00		0.09m ³ / 20kg / 1pcs

Black Painted / Verniciata Nera

	H74	BAQ2.10		0.07m ³ / 18kg / 1pcs
	H110	BAQ2A.10		0.09m ³ / 20kg / 1pcs

Q3

H74-H110 square steel table base, 80x80mm steel column with cross.

Base per tavolo quadrata in acciaio H74 e H110, colonna in acciaio 80x80mm, crociera.

Top max dimensions / Massima dimensione piano

Available table tops / Piani tavolo disponibili

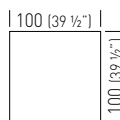

compactop
laminated
iron

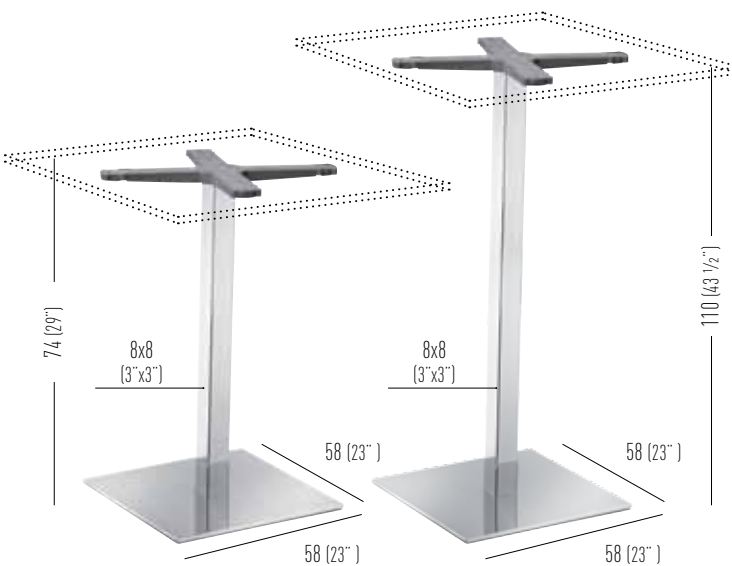

Finishes for Q bases / Finiture per basamenti serie Q

Polished Steel-Chromed Column / Acciaio Lucido-Colonna Cromata

	H74	BAQ3.A		0.07m ³ / 23kg / 1pcs
	H110	BAQ3A.A		0.09m ³ / 25kg / 1pcs

Satin Steel-Satin Column / Acciaio Satinato-Colonna Satinata

	H74	BAQ3.S		0.07m ³ / 23kg / 1pcs
	H110	BAQ3A.S		0.09m ³ / 25kg / 1pcs

White Painted / Verniciata Bianca

	H74	BAQ3.00		0.07m ³ / 23kg / 1pcs
	H110	BAQ3A.00		0.09m ³ / 25kg / 1pcs

Black Painted / Verniciata Nera

	H74	BAQ3.10		0.07m ³ / 23kg / 1pcs
	H110	BAQ3A.10		0.09m ³ / 25kg / 1pcs



D2

H74-H110 double steel table base, 80x80mm steel columns with cross.
 Base doppia per tavolo H74 e H110 in acciaio, colonne in acciaio 80x80mm, crociere.

Top max dimensions / Massima dimensione piano

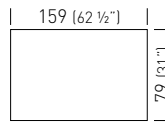

Available table tops / Piani tavolo disponibili

compactop
laminated
iron

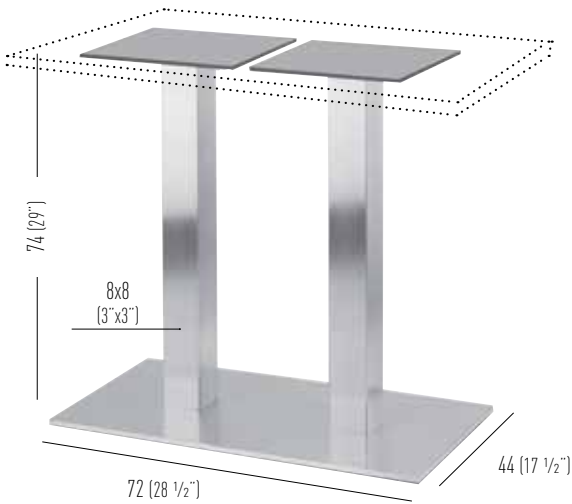

Finishes for D2 bases / Finiture per basamenti serie D2

Polished Steel-Chromed Column / Acciaio Lucido-Colonna Cromata

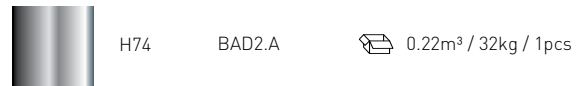

Satin Steel-Satin Column / Acciaio Satinato-Colonna Satinata

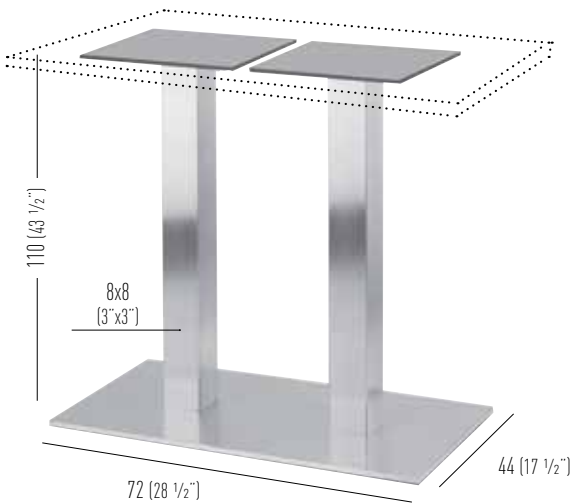
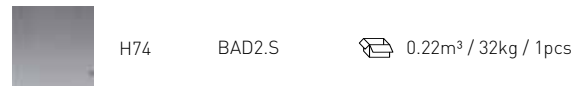

Polished Steel-Chromed Column / Acciaio Lucido-Colonna Cromata

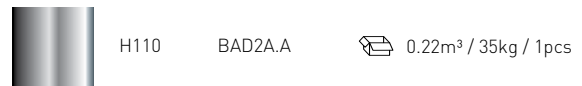

Satin Steel-Satin Column / Acciaio Satinato-Colonna Satinata





HALIFAX

Adjustable square steel table base collection, square steel column with cross.

Collezione basi per tavolo quadrate in acciaio ad altezza regolabile, colonna regolabile quadrata, crociata.

Top max dimensions / Massima dimensione piano

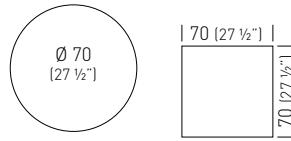

Available table tops / Piani tavolo disponibili

compactop
laminated
iron

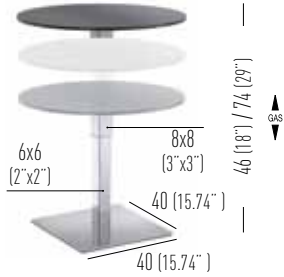

Finishes for HALIFAX bases / Finiture per basamenti serie HALIFAX

Polished Steel-Chromed Column / Acciaio Lucido-Colonna Cromata



BAH1.A

0.13m³ / 18kg / 1pcs



BAH2.A

0.13m³ / 20kg / 1pcs



TATAMI

H74-H110 round steel table base, Ø 60mm steel similar wood-effect column with cross.

Base per tavolo rotonda in acciaio H74 e H110, colonna finto legno Ø 60mm, crociera.

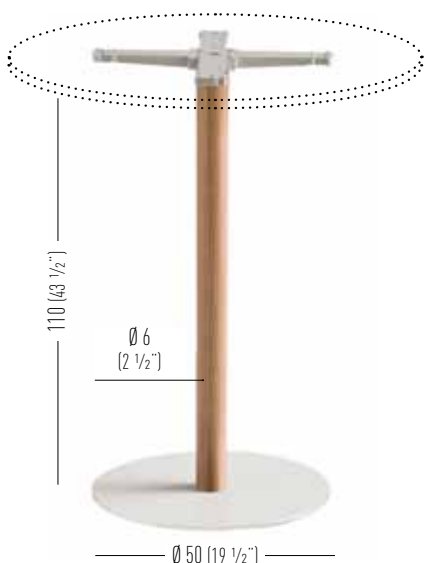
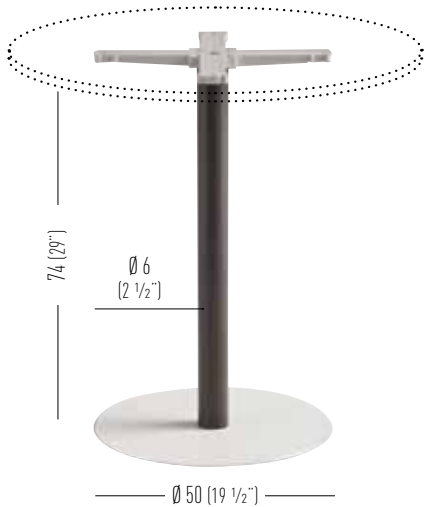

Top max dimensions / Massima dimensione piano

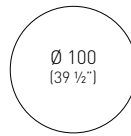

Available table tops / Piani tavolo disponibili

compactop
laminated
iron

Finishes for TATAMI bases / Finiture per basamenti serie Tatami

Polished Steel / Acciaio Lucido



BART.A-__



0.07m³ / 18kg / 1pcs

Satin Steel / Acciaio Satinato



BART.S-__



0.07m³ / 18kg / 1pcs

White Painted / Verniciata Bianca



BART.00-__



0.07m³ / 18kg / 1pcs

Black Painted / Verniciata Nera



BART.10-__



0.07m³ / 18kg / 1pcs

Finishes for Tatami columns / Finiture per colonne serie Tatami



F

Natural Beech effect
Faggio Naturale finto legno



W

Wengé effect
Wengé finto legno



RN

Oak effect
Rovere finto legno

Finishes for TATAMI bases / Finiture per basamenti serie Tatami

Polished Steel / Acciaio Lucido



BARTA.A-__



0.09m³ / 20kg / 1pcs

Satin Steel / Acciaio Satinato



BARTA.S-__



0.09m³ / 20kg / 1pcs

White Painted / Verniciata Bianca



BARTA.00-__



0.09m³ / 20kg / 1pcs

Black Painted / Verniciata Nera



BARTA.10-__



0.09m³ / 20kg / 1pcs

Finishes for Tatami columns / Finiture per colonne serie Tatami



F

Natural Beech effect
Faggio Naturale finto legno



W

Wengé effect
Wengé finto legno



RN

Oak effect
Rovere finto legno





COLORS / COLORI

Techno polymer / Tecnopolimero



Wood finishes / Finiture legni



Metal finishes / Finiture metalli

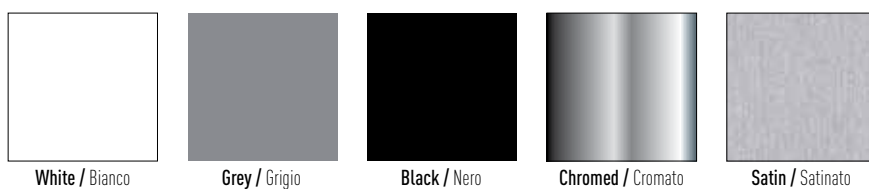



GABER® LITERATURE

All Gaber® literature contains technical information and use-suggestions for those who intend to purchase or already have bought items from the Gaber® range. For Customers' interest, the Company may modify its products without any prior notice. Drawings, quoted materials and catalogue colors and price-lists are shown as a guide only. Dimensions are provided also in inches (") as a guide only. For very precise measurements, please consider the centimeters values. The colors displayed in Gaber® literature, related to technopolymer finishing and coverings, fabrics, leather, lacquered or painted materials, wooden items, may change from time to time. Gaber® reserves the right to suspend the production of any of its products without any notice or reason. All rights of reproduction in whole or in part of Gaber® literature, related to text, images or illustration, or transmitted by any means, electronic or mechanical, including photocopying, recording or any information storage without written permission from Gaber®, are reserved worldwide.

MATERIALS, USE AND MAINTENANCE

Plastic Materials

The Techno Polymer Compounds Gaber® uses on its products are characterized by high structural resistance, heat and abrasion resistance. Gaber® technopolymers are non-toxic, scratch and stain resistant, antistatic and UV-resistant: thanks to all these features these materials have excellent resistance to atmospheric agents. All these materials are recyclable in the full respect of our Natural Environment. Gaber produces plastic injected materials without added chemicals and, as far as possible, recycled technopolymers are sourced as a base raw material, recovered post-consumption.

Guidelines for correct usage: Do not expose plastic surfaces to direct heat sources. Plastic surfaces of Gaber® products usually need to be cleaned with a normal cloth and warm water. For the most persistent stains, a small amount of liquid soap diluted in water may be used. Strictly avoid the use of acetone, trichloroethylene, ammonia, alcoholic substances and detergents containing even a small amount of those substances. We also recommend avoiding all types of abrasive and solvent substances or rough sponges. Any liquid spilt on the product must be wiped up immediately. Even products made especially for outdoor purposes could be affected by atmospheric agents. Products may undergo exterior changes due to particular exposure to heat, humidity and salinity. Products may change color and shade if exposed to direct sunlight. An appropriate and frequent maintenance and cleaning of the products enhances its durability. Maintenance has to be carried out by experienced staff.

Steel

High-resistance steel is used to produce frames for chairs, stools and tables by using square or round tubes as well as solid rod. Products are available in chrome or painted finishes. Special epoxy powder coating used on many Gaber® structures achieves excellent resistance to atmospheric agents.

Aluminum

Gaber® use aluminum to produce frames for chairs, stools and tables. Aluminum surfaces can be anodized, and Gaber® use this special treatment in order to increase resistance to corrosion.

Guidelines for correct usage: both steel and aluminum surfaces usually need to be cleaned with a normal cloth and warm water. For the most persistent stains, a small amount of mild liquid soap diluted in water may be used. Any liquid spilt on the product must be wiped up immediately. We recommend avoiding all types of abrasive creams or pastes, abrasive sponges, chlorine, bleach or strong detergents.

Wood

Our wooden articles are produced in accordance with the European Regulations in force regarding formaldehyde emissions from wood-based products.

Guidelines for correct usage: Wooden articles, being natural materials, can be damaged easily. Small impurities or imperfections are within quality standard range. Plywood surfaces need to be cleaned with a cloth and water. We recommend drying immediately after the cleaning process.

Flexible polyurethane padding

The flexible polyurethane cold-pressed paddings Gaber® uses on some of its upholstered articles do not contain CFC/HCFC (ODP=0: do not contribute the reduction of the atmospheric ozone layer), they are fire-retardant class 1-IM UNI 9175 / CMHR following European Standards.

Coverings: Fabrics and Leathers

Gaber® uses fabrics and leathers that belong to a wide range of colors and patterns, which are all tested in order to achieve the best performance, among which resistance to abrasion and artificial light. Fire-retardant fabrics and eco-leather upholstery are also available.

Guidelines for correct usage: Clean leathers with a soft cloth with water. Refer to technical specifications for fabric cleaning.

PACKAGING AND RECYCLING

Our packages are designed to optimize storage and transport requirements, they are made of 90% recycled raw material and are completely recyclable in themselves. The optimization of packaging in terms of volume and weight delivers a lower consumption of energy in many forms, helping the environment and a consequent saving on transport costs. In order to avoid the loss of components, packaging must be disposed only after completing the assembly of the products. Once the product has been dismantled, the product itself or its components must be given to public garbage system, according to local rules.

INNAPROPRIATE USES OF THE PRODUCT

Avoid any improper use of the product: do not step on the product, do not stand on footrest or on armrests, do not seat on the back or on armrest, do not use the chair as a ladder. The product should not be subjected to swinging back and forwards that may damage the furniture or result in injury to the user. When lifting or moving the product, hold it by the main structure and not just under the seat. Gaber® will accept no liability for any damages caused to property or persons subsequent to incorrect or improper handling of the product. Gaber® also declines any responsibility in cases of damage caused to fragile floors.



DOCUMENTAZIONE GABER®

La documentazione Gaber® contiene informazioni tecniche e consigli d'uso per chi vuole acquistare o possiede articoli facenti parte della gamma prodotti Gaber®. Nell'interesse della clientela, Gaber® si riserva il diritto di modificare i propri modelli in ogni momento, senza obbligo di preavviso. I disegni, le quote, i materiali ed i colori dei cataloghi e del listino Gaber® si intendono a titolo puramente indicativo. Le dimensioni in pollici (") sono da considerarsi indicative. Per misure precise utilizzare le dimensioni in centimetri. I toni di colore rappresentati o presenti nelle palette colori e rivestimenti, relativi ai tessuti, alla pelle, alle laccature, ai vetri, e alle essenze legno, sono indicativi, in quanto passibili di variazioni da partita a partita. Gaber® declina ogni responsabilità in relazione a leggere differenze di tonalità. Gaber® si riserva inoltre il diritto di ritirare, sospendere o cessare la produzione di ogni singolo suo prodotto in qualsiasi momento e a sua discrezione senza darne preventivo avviso. Tutti i diritti di riproduzione, anche parziale, di cataloghi e listini Gaber® relativi a testi, immagini, illustrazioni, disegni, sia con mezzi meccanici che elettronici, incluso fotocopie o la formazione di sorgenti di informazione, senza il preventivo permesso scritto di Gaber®, sono globalmente riservati.

MATERIALI UTILIZZATI E MANUTENZIONE

Le Materie Plastiche

I compound di tecnopolimeri utilizzati da Gaber® nella realizzazione dei propri prodotti sono caratterizzati da un'elevata resistenza strutturale, termica e all'abrasione. Il tecnopolimero componente dei prodotti Gaber® è atossico, antimacchia, antigraffio, antistatico e anti-uv: qualità che lo rendono ottimamente resistente agli agenti atmosferici. I tecnopolimeri utilizzati da Gaber® sono integralmente riciclabili, nel pieno rispetto del nostro Ambiente Naturale. Gaber produce articoli termoplastici senza additivi chimici e, ove possibile, vengono utilizzati tecnopolimeri riciclati derivanti da post-consumo.

Piccole Accortezze: I materiali plastici utilizzati non possono sopportare fonti di calore diretta sulla superficie. Le superfici plastiche dei prodotti Gaber® possono essere pulite con un panno umido e soffice imbevuto in acqua. Per le macchie più ostinate è possibile diluire in acqua del sapone neutro liquido con moderazione. Non utilizzare acetone, trielina, ammoniaca, sostanze alcoliche o detersivi che contengano anche piccole quantità di tali detergenti. Non utilizzare a contatto con il prodotto sostanze abrasive o solventi, strumenti di pulizia ruvidi. I liquidi versati sul prodotto devono essere asciugati subito. I prodotti destinati all'uso esterno subiscono comunque nel tempo l'azione degli agenti atmosferici. Eventuali alterazioni superficiali possono verificarsi a specifiche condizioni di temperatura, umidità e salinità. Il prodotto se esposto alla luce diretta del sole può essere soggetto a variazioni di colore. Una corretta e frequente manutenzione e pulizia aumentano la durabilità del prodotto. Interventi di manutenzione devono essere eseguiti da personale esperto.

L' Acciaio

L'acciaio ad alta resistenza è utilizzato nelle strutture di tavoli, sedie e sgabelli, realizzati da Gaber® per mezzo di tubolari a sezione quadrata e rotonda, o con tondino. I prodotti sono disponibili con finitura cromata o verniciata. La speciale verniciatura a polveri epossidiche utilizzata da Gaber® per alcune strutture dei propri prodotti raggiunge una resistenza ottimale agli agenti atmosferici.

L' Alluminio

Gaber® utilizza l'alluminio per realizzare le strutture di tavoli, sedie e sgabelli. La finitura per mezzo del trattamento superficiale di anodizzazione, utilizzata in alcuni prodotti, ha lo scopo di aumentarne la resistenza alla corrosione.

Piccole Accortezze: sia le superfici metalliche in acciaio che in alluminio devono essere pulite con un panno umido e soffice imbevuto in acqua calda. Per le macchie più ostinate è possibile diluire in acqua del sapone neutro liquido con moderazione. Asciugare sempre dopo la pulizia con un panno morbido. Non usare creme o paste per pulire i metalli, non usare cloro, candeggina o detergenti aggressivi. Non usare paste o spugne abrasive che possano graffiare le superfici metalliche.

Il legno

I prodotti Gaber® con elementi in legno sono prodotti di accordo con le vigenti normative Europee rispetto alle emissioni di formaldeide.

"Compound-wood" è il particolare materiale utilizzato da Gaber® per la realizzazione dei prodotti Alhambra-Eco ed Epica-Eco. Questo materiale utilizza fibre di legno derivanti dagli stessi processi di produzione con cui Gaber realizza elementi in materiale legnoso. Niente viene sprecato.

Piccole Accortezze: Le superfici in legno, essendo un materiale naturale, potrebbero, nel tempo, subire alterazioni di colore con l'utilizzo e con l'esposizione alla luce. Inoltre, per loro natura, tali superfici sono facilmente danneggiabili, alcune piccole impurità e imperfezioni rientrano negli standard di qualità accettati. Le superfici in legno non possono sopportare fonti di calore dirette. Pulire le superfici in legno con un panno umido e soffice, imbevuto in acqua tiepida. Asciugare immediatamente dopo la pulizia.

Le imbottiture in poliuretano flessibile

Le imbottiture di alcuni prodotti Gaber® sono realizzate in poliuretano flessibile, stampato a freddo, privo di CFC/HCFC (ODP=0 : non contribuisce alla riduzione dello strato di ozono atmosferico), autoestingente classe 1-IM Uni 9175 / CMHR, seguendo le normative Europee in materia.

I rivestimenti: tessuti e pelli

Tessuti e Pelli utilizzati da Gaber® appartengono ad un'ampia gamma di colori e trame, tutti scelti tra un range di prodotti testati con l'obiettivo di ottenere le migliori caratteristiche prestazionali, quali la resistenza all'abrasione, allo sfregamento e alla resistenza alla luce artificiale. Sono disponibili categorie di tessuti ignifughi e rivestimenti in finte pelli.

Piccole Accortezze: pulire le Pelli con un panno bianco umido di sola acqua. Per la pulizia dei tessuti consultare la scheda tecnica specifica.

IMBALLI E RICICLO

I nostri imballi sono realizzati con l'obiettivo di ottimizzare trasporti e stoccaggio; sono realizzati per il 90% di materiali riciclati e totalmente riciclabili. L'ottimizzazione dell'imballo in termini di volume e peso comporta un minore dispendio di energia, con un conseguente risparmio nei costi di trasporto e un importante aiuto alla salvaguardia del nostro Ambiente Naturale. È consigliabile lo smaltimento degli imballi solo a completamento dell'assemblaggio, onde evitare lo smarrimento di eventuale ferramenta e componenti. Una volta dismesso, il prodotto o i suoi componenti vanno conferiti ai sistemi pubblici di smaltimento secondo quanto previsto dalla legislazione locale in vigore.

USO IMPROPRIO DEI PRODOTTI

Sono da considerarsi usi impropri e/o scorretti del prodotto il salire in piedi su tavoli, sedie, sgabelli, poggiatesta, sedersi su schienali, braccioli, utilizzare i prodotti come scaletta. Evitare oscillazioni che potrebbero pregiudicare il funzionamento e la sicurezza dell'utente. Per sollevare o spostare un prodotto non afferrare sotto il sedile, bensì afferrare saldamente la struttura portante. Il prodotto non deve essere sottoposto a carichi decentrati, è stato progettato per essere utilizzato in condizioni normali di appoggio (su quattro gambe o sulla base). Gaber® declina ogni responsabilità per danni causati a cose o a persone derivanti da uso non corretto del prodotto; l'azienda inoltre si solleva da ogni responsabilità per danni provocati su pavimenti e superfici delicate o tenere.



DOCUMENTACION GABER®

Toda la documentación Gaber® contiene una serie de informaciones técnicas y consejos para el usuario para quien quiera comprar o para quien posea productos pertenecientes a la gama Gaber®. En el interés de los clientes, Gaber® se reserva el derecho de poder modificar o mejorar sus productos sin avisar antes.

Los dibujos, las medidas, los materiales y los colores se ilustran exclusivamente a modo de ejemplo y son indicativas. Las tonalidades de los colores del muestrario relativas a las telas, pieles, pintura, esencias de las maderas, pueden variar según partida.

Gaber® declina todo tipo de responsabilidades con relación a pequeñas diferencias de color. Gaber® se reserva además el derecho de retirar, suspender o cesar la producción de cualquier producto en cualquier momento y a propia discreción sin dar previo aviso.

Todos los derechos de reproducción, incluso parcial, de los catálogos y listas de precios Gaber® relativos a los textos, imágenes, ilustraciones, diseños ya sea por medios mecánicos o electrónicos, incluyendo el fotocopiado o la formación de fuentes de información, sin el permiso previo por escrito de Gaber®, son reservados a nivel mundial.

MATERIALES, USO Y MANTENIMIENTO

Material Plástico

Tecnología de Polímeros compuestos que Gaber® utiliza en sus productos se caracterizan por una alta resistencia estructural, al calor y una alta resistencia a la abrasión. Los Tecnopolímeros de Gaber® no son tóxicos, son resistentes a arañazos y manchas, antiestáticos y UV-resistente: gracias a esto los materiales tienen una excelente resistencia a los agentes atmosféricos. Todos estos materiales son reciclables en el pleno respeto de nuestro medio ambiente. Gaber® produce plástico inyectado sin productos químicos y materiales añadidos y, cuando sea posible, tecnopolímeros reciclados se obtienen como materia prima básica, recuperado de post-consumo.

Pequeñas atenciones a: no exponga las superficies de plástico a fuertes fuentes de calor directo. Las superficies de plástico de los productos Gaber® generalmente necesitan ser limpiadas con un paño normal y agua tibia. Para las manchas más persistentes se puede utilizar una pequeña cantidad de jabón líquido diluido en agua. Estrictamente evitar el uso de acetona, tricloroetileno, amoníaco, sustancias alcohólicas y detergentes que contiene incluso sólo una pequeña cantidad de esas sustancias. Se recomienda también para evitar todo tipo de sustancias solventes y abrasivos o esponjas ásperas. Cualquier fracción de líquido sobre el producto debe ser borrado de inmediato. Incluso los productos hechos especialmente para el exterior podrían ser afectados por los agentes atmosféricos. Productos podrían someterse a posibles cambios en la exposición especial al calor, la humedad y la salinidad. En casos excepcionales y para una vida larga, los productos podrían cambiar de tonalidad y sombra, si se expone a fuerte luz solar directa. Un mantenimiento y limpieza adecuada y frecuente de los productos aumenta su durabilidad. Mantenimiento tiene que llevarse a cabo por personal de experiencia.

Acero

Acero de alta resistencia se utiliza para producir las estructuras de las sillas y de las mesas, utilizando tubos cuadrados o redondos, así como barilla sólida. Los productos están disponibles en cromo o acabados pintados. La pintura en polvo epoxi especial, utilizada en muchas estructuras Gaber®, logra una excelente resistencia a los agentes atmosféricos.

Aluminio

Gaber® utiliza aluminio, ligero y resistente, para producir estructuras para las sillas y las mesas. Superficies de aluminio pueden ser anodizado, y Gaber® utilizan este tratamiento especial con el fin de aumentar la resistencia a la corrosión.

Pequeñas atenciones a: tanto las superficies de aluminio que acero se deben limpiar con un paño normal y agua tibia. Para las manchas más persistentes se puede usar una pequeña cantidad de jabón líquido suave diluido en agua. Cualquier fracción de líquido sobre el producto debe ser borrado de inmediato. Se recomienda evitar todo tipo de cremas abrasivas o pastas, esponjas abrasivas, cloro, lejía o detergentes fuertes.

Las Maderas

Nuestros artículos de madera se producen de acuerdo con la normativa europea vigente en materia de emisiones de formaldehído de los productos a base de madera. Gaber utiliza materias primas de madera que vienen exclusivamente de la cadena de custodia PEFC de materiales certificados.

Pequeñas atenciones a: artículos de madera, siendo materiales naturales, podrían dañarse fácilmente. Las pequeñas impurezas o imperfecciones están dentro del rango estándar de calidad. Superficies de madera moldeada deben ser limpiadas con un paño y agua. Se recomienda secar inmediatamente después del proceso de limpieza.

Espumas

Gaber® utiliza en algunos de sus artículos tapizados una espuma de poliuretano inyectada dentro de un molde, toda las espumas no contienen CFC / HCFC (ODP = 0: no contribuyen a la reducción de la capa de ozono de la atmósfera), y son de clase ignífugo 1-IM Uni 9175 siguiendo Normas europeas.

Revestimientos: Telas y Piel

Gaber® utiliza tela y piel que pertenecen a una amplia gama de colores y diseños, que son todos probados a fin de lograr las mejores prestaciones, entre las que la resistencia a la abrasión y la luz artificial. Telas ignífugas y para exterior, tapicería en eco-piel, también están disponibles.

Pequeñas atenciones a: limpie las pieles con un paño suave con agua. Consulte las especificaciones técnicas de limpieza para las telas.

EMPAQUE Y RECICLABILIDAD

La gama de productos Gaber® está constituida por la mayor parte de elementos completamente reciclables. Nuestros embalajes se escalan con el fin de optimizar los requisitos de almacenamiento y de transporte, que están hechos de 90% materia prima reciclada y son totalmente reciclables. La optimización de los embalajes en términos de volumen y peso ofrece un menor consumo de energía en muchas formas, ayudando al medio ambiente y el consiguiente ahorro en los costes de transporte. A fin de evitar la pérdida de componentes, el embalaje debe eliminarse sólo después de completar el montaje de los productos. Una vez que el producto ha sido desmantelado, el propio producto o sus componentes se debe dar a sistema público de reciclaje, de acuerdo con las normas locales.

USOS INADECUADO DEL PRODUCTO

Evite cualquier uso inadecuado del producto; no subir/caminar sobre el producto, no se pare en el reposapiés o en los brazos, no sentarse en el espaldar o en el reposabrazos, no utilice la silla como una escalera. El producto no debe ser sometido a pesos desequilibrados, ya que está diseñado para un descanso adecuado en el punto de apoyo (en cuatro patas o en la base). Cuando levante o mueva el producto, manténgalo en la estructura principal y no sólo bajo el asiento. Gaber® aceptará ninguna responsabilidad por los daños y perjuicios causados a bienes o personas posteriores a un manejo incorrecto o inadecuado del producto. Gaber® se libera de cualquier responsabilidad en caso de daños causados a los suelos frágiles.



DOCUMENTATION GABER®

Notre documentation contient des informations techniques et des conseils pour l'utilisation des produits, pour les futurs clients Gaber® ou pour qui est déjà en possession d'un produit Gaber®. Dans l'intérêt de la clientèle, Gaber® se réserve le droit de modifier ses modèles, à n'importe quel moment, sans aucun préavis.

Les dessins, les descriptions, les cotes, les matériaux et les couleurs du catalogue et du tarif sont purement indicatifs. Les dimensions en pouce sont indicatives. Pour des dimensions plus précises, il est recommandé d'utiliser les dimensions en centimètre. Les tonalités des couleurs qui sont représentées sur la carte couleur, relatives aux tissus, au cuir, aux polipro, aux essences de bois sont purement indicatives car elles peuvent varier d'un lot à un autre. Gaber® décline toute responsabilité en ce qui concerne toute différence de tonalité.

Gaber® se réserve le droit de retirer, de suspendre ou de cesser la production de tout article, sans aucun préavis. Tout droit de reproduction, même partielle, des catalogues, relatif aux textes, images, illustrations, dessins, par des moyens mécaniques, électroniques, par photocopie, ou autre source d'information, sans le consentement préalable de Gaber®, est réservé.

MATERIAUX UTILISES ET LEUR ENTRETIEN

Matière plastique

Les billes de technopolymère utilisées par Gaber® pour fabriquer ses produits ont les caractéristiques suivantes : résistance structurelle thermique et à l'abrasion. Le technopolymère est non toxique, anti tache, il est anti statique et anti UV ; ces qualités le rendent très résistant aux agents atmosphériques. Le technopolymère est entièrement recyclable, dans le respect de la charte écologique. Quelques informations pour l'entretien : les matières plastiques ne doivent pas être en contact avec une source de chaleur directe. Le liquide versé sur un plateau doit être immédiatement essuyé, les articles réservés à un usage externe peuvent subir à la longue l'action d'agents atmosphériques, tels que la salinité, l'humidité, les rayons de soleil, qui peuvent en altérer la superficie et la couleur. Nous recommandons un entretien régulier ainsi qu'un nettoyage correcte et fréquent, ce qui augmentera la durée de vie du produit. L'entretien doit être effectué par des personnes expertes.

Acier

L'acier utilisé pour la fabrication des structures de tables, chaises, et tabourets Gaber® est très résistant. Il est travaillé sous forme de tube à section carrée ou ronde. La finition peut être chromée ou vernis. Le vernissage spécial à époxy, utilisé par Gaber®, a une résistance optimale aux agents atmosphériques.

Aluminium

L'aluminium anodisé utilisé pour la réalisation de structures de tables, chaises et tabourets augmente la résistance à la corrosion. Conseil d'entretien pour les surfaces en acier et/ou en aluminium : nettoyer avec un chiffon doux, humide, imprégné d'eau chaude. Pour les taches éventuelles, on peut ajouter un peu de détergent à usage domestique. Il est recommandé de bien sécher la surface ensuite. Il ne faut pas utiliser de pâte et/ou crème pour métal, il ne faut pas utiliser de chlore, de javel ou autre détergents agressifs. Il ne faut pas utiliser de pâte ou d'éponges abrasives, qui pourraient endommager en rayant, les superficies.

Bois

Les articles Gaber® avec bois, sont fabriqués selon les normes européennes en vigueur, sans formaldéhyde. (par rapport à l'émission de formaldéhyde). Le matériel utilisé pour la fabrication des articles ALHAMBRA ECO et EPICA ECO est un mélange de sciure de bois rendu compact et dérivant de matériel recyclé. Il n'y a ainsi aucun gaspillage. Le bois étant une matière naturelle, peut, avec le temps et suivant l'exposition à la lumière, subir de légères modifications au niveau de la couleur. Ces produits, de par leur nature, peuvent s'abimer facilement ; nous tenons aussi à préciser que certaines imperfections correspondent à un standard normal de qualité. Il est recommandé enfin, de ne pas approcher la superficie à une source de chaleur directe. Les superficies se nettoient à l'aide d'un chiffon doux, légèrement humide. Sécher toujours ensuite.

Remboufrage en polyuréthane « flexible »

Le rembourrage de certains articles Gaber® est réalisé en polyuréthane « flexible », injecté à froid, sans particules de CFC/HCFC (ODP=0, ne réduit pas la couche d'ozone), ignifugé en classe 1-IM UNI 9175 / CMHR, selon les normes européennes en vigueur.

Revêtement : tissus et cuir

Gaber® a au choix une large gamme de couleurs et de trames, choisis parmi des tissus, des cuirs, des ecopelle testés et garantissant une bonne résistance aux frottements, aux abrasions, à la lumière artificielle. Nous avons aussi une gamme de revêtements non feu.

Informations et entretien : nettoyer les peaux avec un chiffon blanc, légèrement humide. Pour l'entretien des tissus, consulter la fiche technique, spécifique.

EMBALLAGE ET RECYCLAGE

Nos emballages sont conçus de façon à optimiser le transport et le stockage ; ils sont réalisés à 90% avec du matériel recyclé et sont complètement recyclables. L'emballage, optimisé au maximum en ce qui concerne son volume et son poids, permet une économie d'énergie, de main d'œuvre et de coût de port, sans oublier la sauvegarde de notre environnement. Il est vivement conseillé de monter complètement l'article Gaber® avant de procéder à l'élimination du carton, ceci, afin d'éviter de perdre la visserie et / ou les divers composants de l'article en question.

Lorsqu'un produit Gaber® arrive en fin de vie, il est recommandé de porter les diverses parties qui le compose à la déchèterie, selon la loi du pays en vigueur

USAGE INCORRECT DES PRODUITS

Les tables, chaises, tabourets ou repose pieds ne sont pas fait pour monter dessus, il ne faut pas s'asseoir sur les dossiers ou les accoudoirs ou se servir de ces articles comme d'un escabeau. Il faut éviter de se balancer d'avant en arrière sur les assises, de façon à éviter les accidents. Pour soulever ou déplacer une chaise ou tabouret, il est recommandé de le prendre par le châssis et non par l'assise. Le produit ne doit pas être soumis à des charges excessives ou décentrées, il a été conçu pour un usage normal de simple appui (sur 4 pieds ou sur pied central).

Gaber® décline toute responsabilité pour les dommages causés à personne ou choses, qui pourraient dériver d'un usage incorrect du produit. L'usine décline aussi toute responsabilité pour les dommages sur parquets ou sol délicats.

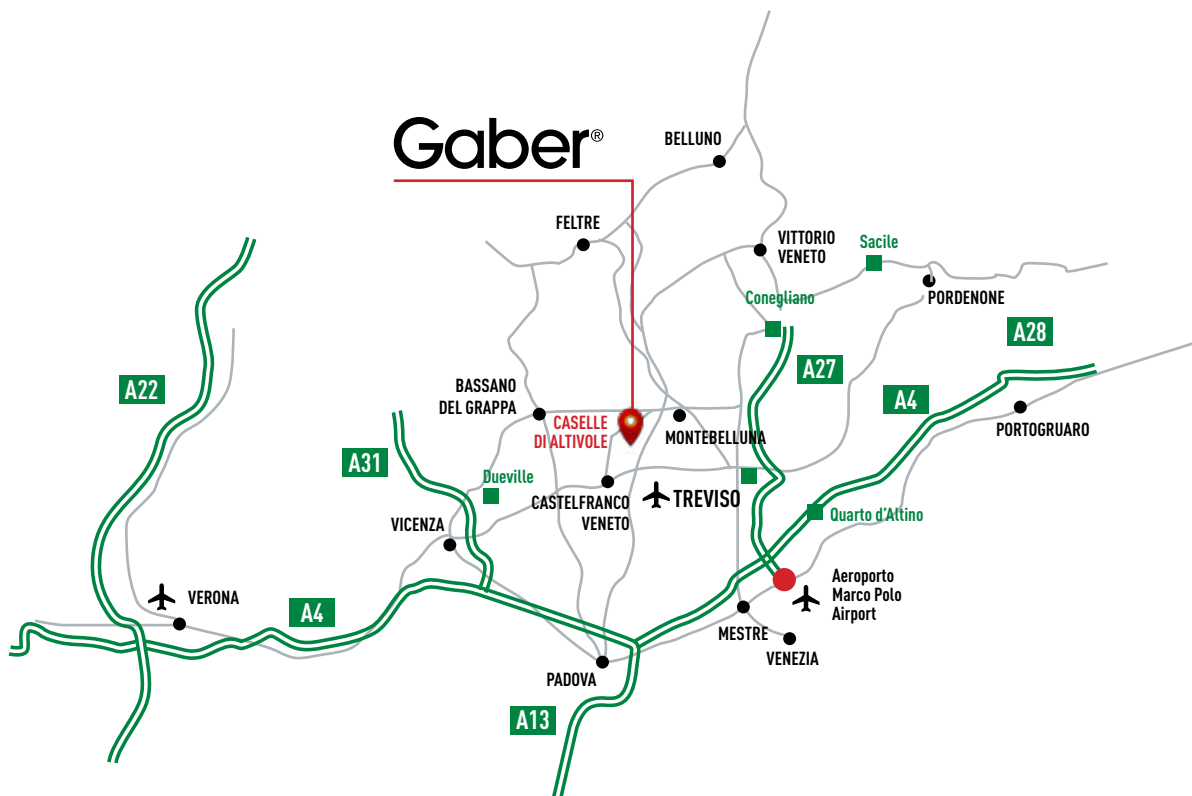
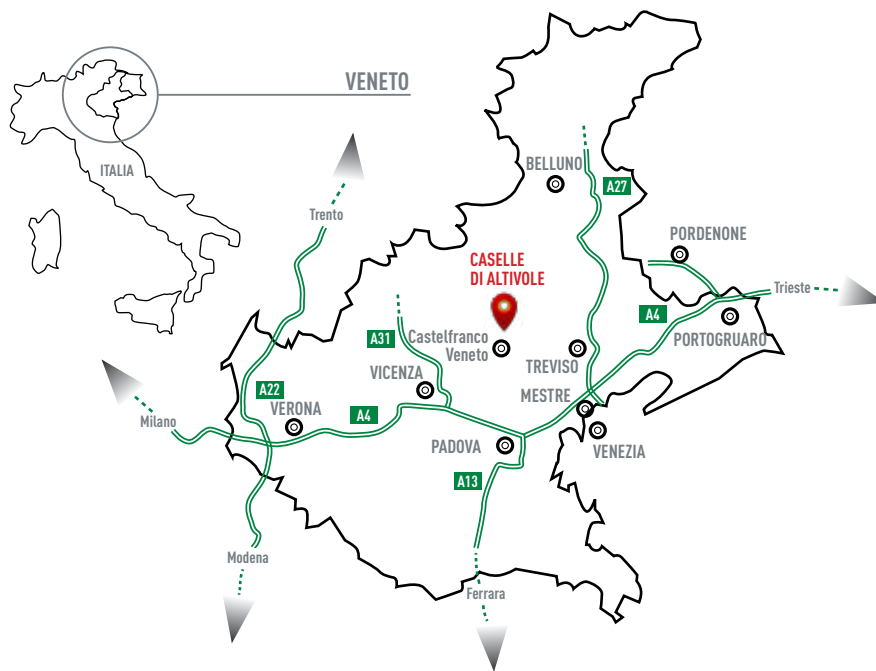

A.D. and Project:
studiobluart.it

Print:
Litografia Effe e Erre (Trento)

Gaber
Via Schiavonesca, 75/1
31030 Caselle di Altivole (TV)
ITALY
Ph. +39 0423 915521
Fax +39 0423 919417
gaber.it

Gaber®