

Seating



.mdd

Contents:

Agora – 3

New School – 15

Ultra – 25

Ulti – 35

Grace – 47

Mesh – 55

Bazalto – 63

Shila – 69

Kaiva – 81

Frank – 89

Sava – 97

Gaya – 105

Tanya – 111

Ayla – 117



Agora

by Form Us With Love

Being comprised of five elements, it can serve as a bench, a shelf, a sofa or a combination of these units at the same time.

With two seat types, table top and three-tiered shelving unit to choose from, Agora embodies flexibility. Built on tubular structure, it can be as long as you need it to be. Combine these square-shaped units and create any sitting area suited

to the character and size of space arranged – from partitioned meeting point to a place to socialise or to welcome visitors. With original meaning of its name in mind, Agora fosters collaborative behaviours.



609mm | 25" 609mm | 25"

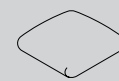
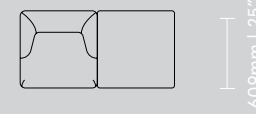

Bench ES01

609mm | 25"

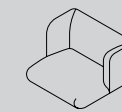
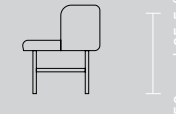

Sofa ES02

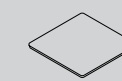
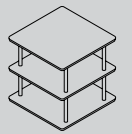

Table ES03



Shelf ES04



AR1K elements
to end any configuration

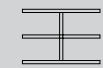

AR1S element
to connect separate frame

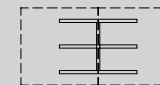

Frame AR01



Frame AR02

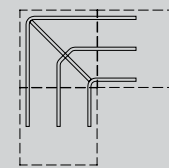

Frame AR03

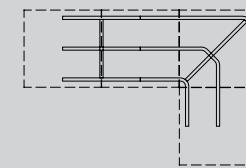

Frame AR04

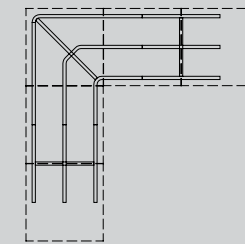

Frame AR05

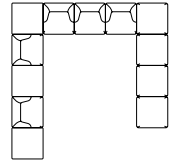

Frame: AR1K + AR02 + AR01 +
3 x AR1S + AR04 + AR03
Elements for frame units:
2 x ES03 + ES04 + 5 x ES02 + 4 x ES01
3016 / 3045 / 913
122 7/8" / 125" / 36"









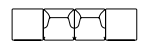

Frame: 2 x AR01 + AR1K + AR1S
Elements: 2 x ES02 + 2 x ES03
 2436 / 609 / 652
 100" / 25" / 25 5/8"



New School

by Form Us With Love

To create opportunities through small means, it offers a vast number of combinations tailored to the way you want it.

Find possibilities within its humane and simple construction to make a complete range of typologies for the kinds of activities happening today within the many spaces from cafe to home and office. Growing on the classic school chair, New School provides a range

of options available to meet the varied ergonomic requirements of modern office environment – add castors for mobility, headrest for increased comfort or choose an option with armrest to support a range of arm postures.

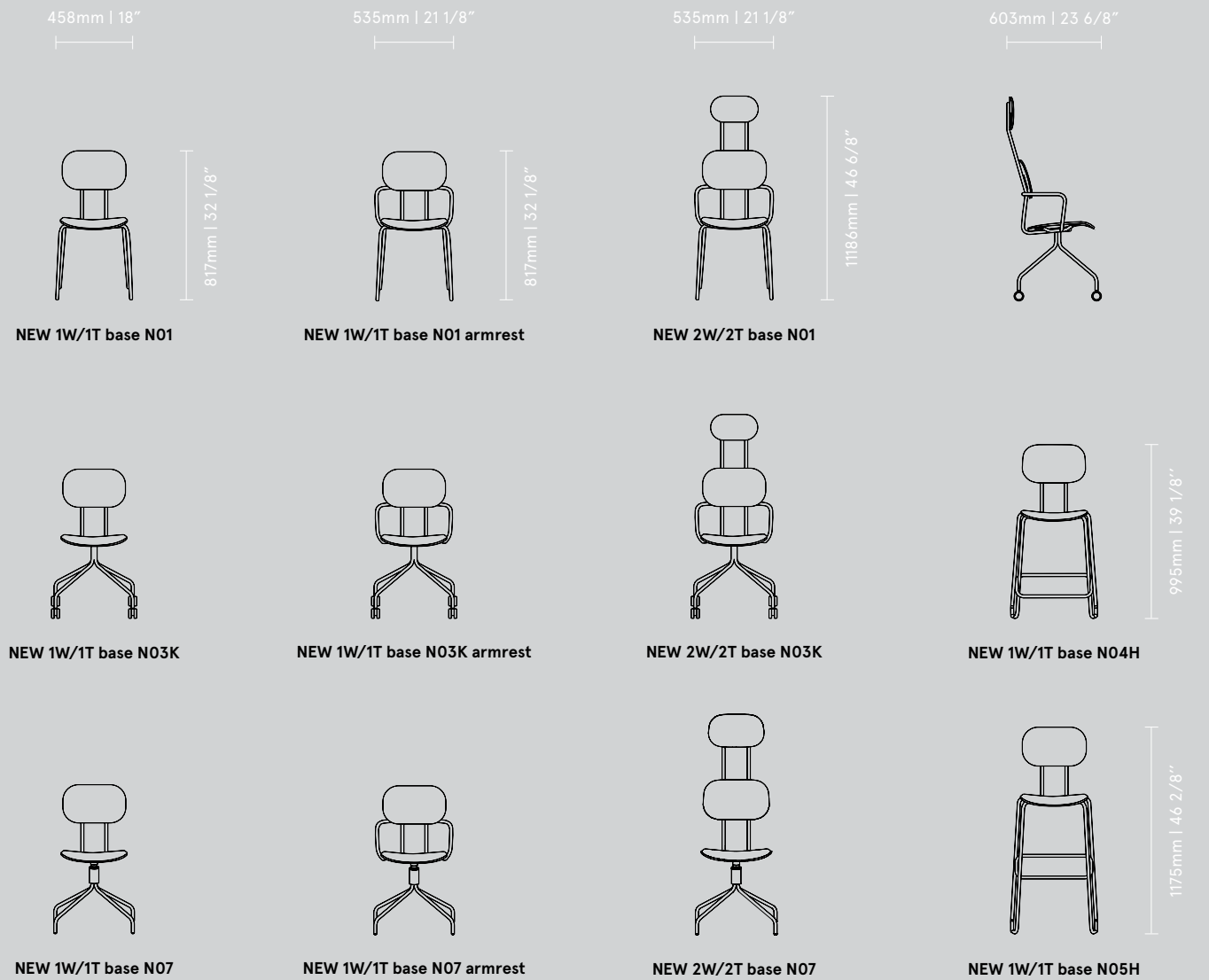

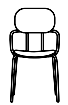

New School 1T with N01 base + armrest
538 / 550 / 817
21 1/8" / 21 5/8" / 32 1/8"



New School 2T with N03K base + armrest
550 / 603 / 1186
21 5/8" / 23 6/8" / 46 6/8"



New School 1T with N03K base + armrest
550 / 550 / 817
21 5/8" / 21 5/8" / 32 1/8"



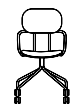

New School 1T with N03K base + armrest
 550 / 550 / 817
 21 5/8" / 21 5/8" / 32 1/8"



New School 1T with N05H base
517 / 550 / 1175
20 / 8" / 21 5/8" / 46 2/8"





Ultra

by Krystian Kowalski

Ergonomically-shaped shell seat and numerous metal and wooden base options – Ultra means many solutions.

The most striking feature of the Ultra armchair forms the cushion fastened to its backrest. Designed not only to catch the eye, it provides comfort needed to make sitting a pleasure. Fusing distinctive design and maximum functionality, the Ultra armchair will fit multitude of

uses around your office or even at home — from formal gatherings in conference room to family meetings in dining area.



600mm | 23 5/8"

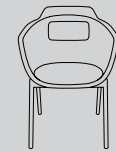
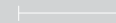

ULTRA F base P1

600mm | 23 5/8"

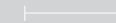

ULTRA F base P7



850mm | 33 4/8"



ULTRA FW base P8

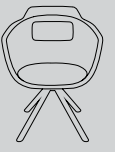

ULTRA FW base P9



ULTRA F base P11



ULTRA F base P7



ULTRA F base P11KM/P11KT

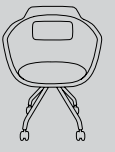

ULTRA F base P7KM/P7KT



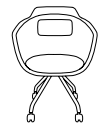

ULTRA F with P7KM/P7KT base
 600 / 600 / 850
 23 5/8" / 23 5/8" / 33 4/8"

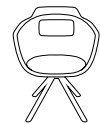

ULTRA FW with P9 base
 600 / 600 / 850
 23 5/8" / 23 5/8" / 33 4/8"

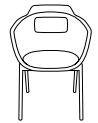
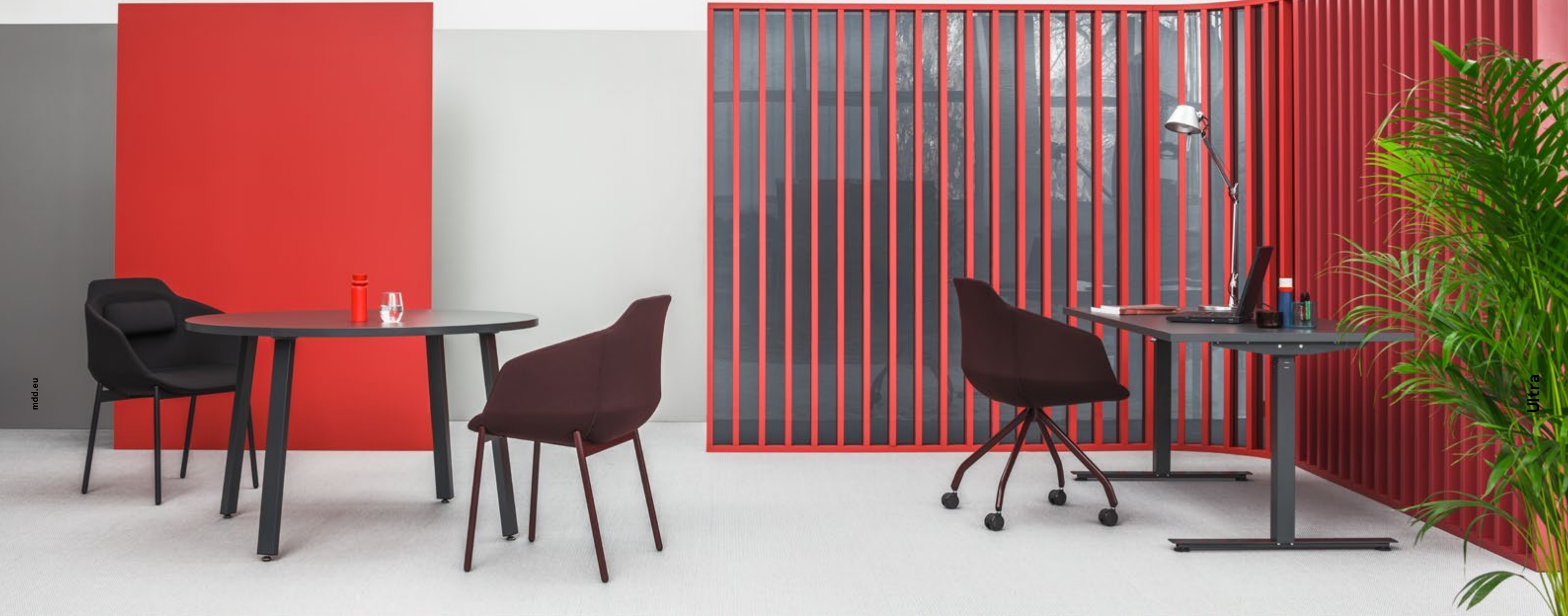

ULTRA F with P1 base
 600 / 600 / 850
 23 5/8" / 23 5/8" / 33 4/8"



ULTRA F with P7KM/P7KT base
 600 / 600 / 850
 23 5/8" / 23 5/8" / 33 4/8"

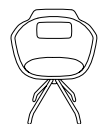

ULTRA F with P7 base
600 / 600 / 850
23 5/8" / 23 5/8" / 33 4/8"





Ulti

by Krystian Kowalski

A combination of minimalist design and high comfort – Ulti sets a new standard for conference chairs.

With a wide range of finishes and base options it perfectly adapts to a variety of aesthetics, work styles, and environments — from offices or public utilities to home interiors. Designed to be eye-catching yet functional, the Ulti chair can be provided with castors or glides and

armrests as well. Whether with hard-wearing metal base, or wooden one with homely feel, it ensures long-term comfort.



450mm | 17 6/8"



ULTI K base P1

570mm | 22 4/8"



ULTI K base P7

900mm | 35 3/8"

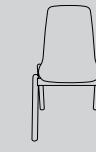

ULTI KW base P8

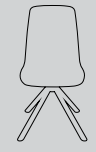

ULTI KW base P9



ULTI K base P2

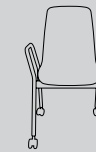
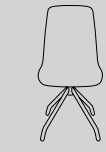

ULTI K base P3KM/P3KT

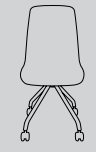

ULTI K base P7KM/P7KT

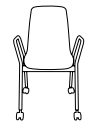

ULTI K with P3KM base
450 / 570 / 900
17 6/8" / 22 4/8" / 35 3/8"

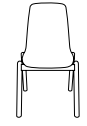

ULTI K with P1 base
450 / 570 / 900
17 6/8" / 22 4/8" / 35 3/8"

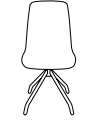

ULTI K with P7 base
450 / 570 / 900
17 6/8" / 22 4/8" / 35 3/8"

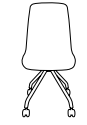

ULTI K with P7KT base
450 / 570 / 900
17 6/8" / 22 4/8" / 35 3/8"





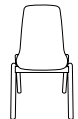

ULTI KW with P8 base
45° / 57° / 90°
17 6/8" / 22 4/8" / 35 3/8"





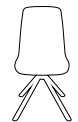

ULTI KW with P9 base
 450 / 570 / 900
 17 6/8" / 22 4/8" / 35 3/8"

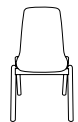

ULTI KW with P8 base
 450 / 570 / 900
 17 6/8" / 22 4/8" / 35 3/8"



Grace

by Krystian Kowalski

The Grace furniture family includes sofa, armchair and two tables – featuring sleek design and thoughtful proportions, it graces every room.

Thanks to the combination of distinct seat lines and minimalist frame style it gains a sculptural character. Available in a variety of finishes, this line provides a wide spectrum of arrangement possibilities. That's why not only does the Grace sofa work well in a spacious lobby

of skyscrapers but also in a tiny home office. When combined together, sofas and tables create a lounge area infused with a touch of elegance. Thoughtfully chosen seat materials ensure high comfort of use.



700mm | 27 4/8"

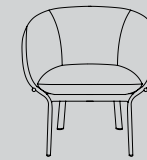

GR01

760mm | 29 7/8"

650mm | 25 5/8"

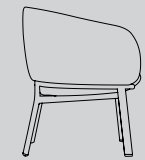

1280mm | 50 3/8"

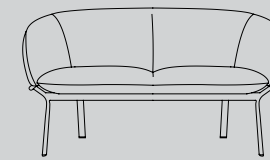

GR02

760mm | 29 7/8"

1860mm | 73 2/8"

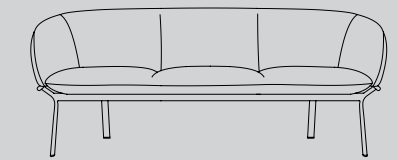

GR03

760mm | 29 7/8"

800mm | 31 4/8"



GR01S

450mm | 17 6/8"

1000mm | 39 3/8"

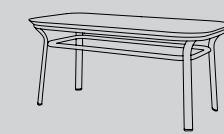

GR02S

450mm | 17 6/8"



mdd

mdd

mdd.eu

Grace



GR01
700 / 650 / 760
27 4/8" / 25 5/8" / 29 7/8"

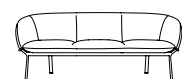

GR03
1860 / 650 / 760
73 2/8" / 25 5/8" / 29 7/8"



GR02S
1000 / 800 / 450
39 3/8" / 31 4/8" / 17 6/8"





Grace GR01
 700 / 650 / 760
 27 4/8" / 25 5/8" / 29 7/8"



Grace GR02S
 1000 / 500 / 450
 39 3/8" / 19 5/8" / 17 6/8"



Mesh

by Krystian Kowalski

Designed to create friendly office spaces, it can be easily customised to fit a specific space or need.

The Mesh line offers a sofa, an armchair and two tables that bring comforts of home to the workplace. Thanks to its design, it may serve as a place to relax as well as a piece of decoration, and finally as a functional item. The shield available in three sizes becomes the most striking feature of this range – use it to create a

comfortable oasis or a less informal meeting area. Being more than beautifully crafted seating solution, Mesh combines a tailored, craft-based approach with the precision of high-volume technology.



850mm | 33 4/8"

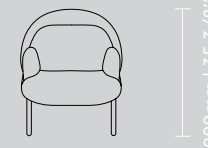

Mesh F small shield

870mm | 34 2/8"

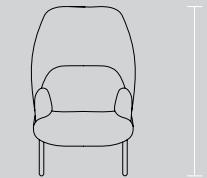

Mesh F medium shield

1000mm | 39 3/8"

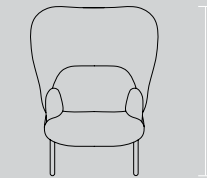

Mesh F large shield

900mm | 35 3/8"

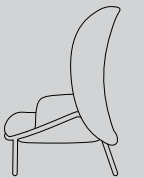

1800mm | 70 7/8"



Mesh S small shield

1820mm | 71 5/8"

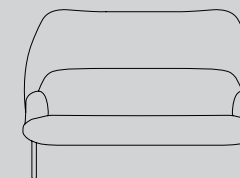

Mesh S medium shield

1900mm | 74 6/8"

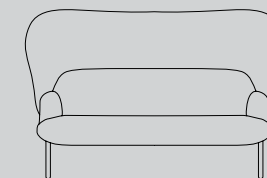

Mesh S large shield

650mm | 25 5/8"

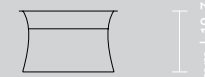

Mesh T1

450mm | 17 6/8"

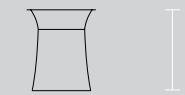

Mesh T2



Mesh F with a small shield
850 / 900 / 900
33 4/8" / 35 3/8" / 35 3/8"



Mesh F with a large shield
1000 / 900 / 1250
39 3/8" / 35 3/8" / 49 2/8"

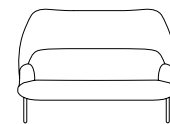

Mesh S with a medium shield
1820 / 900 / 1250
71 5/8" / 35 3/8" / 49 2/8"

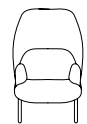

Mesh F with a medium shield
870 / 900 / 1250
34 2/8" / 35 3/8" / 49 2/8"

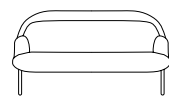

Mesh S with a small shield
1800 / 900 / 900
70 7/8" / 35 3/8" / 35 3/8"

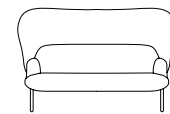

Mesh S with a large shield
1900 / 900 / 1250
74 6/8" / 35 3/8" / 49 2/8"



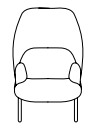

Mesh F with a medium shield
 870 / 900 / 1250
 34 2/8" / 35 3/8" / 49 2/8"



Bazalto

by Andreas Krob

It's a fresh approach to casual seating. The design possibilities are endless and are all up to you.

Inspired by the Giant's Causeway in Northern Ireland, Bazalto is a new, fun and creative way to design a modern seating arrangement for every office space. With a wide array of fabrics in invigorating colours to choose from, it is easy to personalise. Group them to make one large seating piece fostering collaboration or arrange them

separately to create clusters of small units for more privacy. Combine two different heights – the shorter pouf for a seat and the taller one for a backrest – to achieve perfect solution to office seating needs.

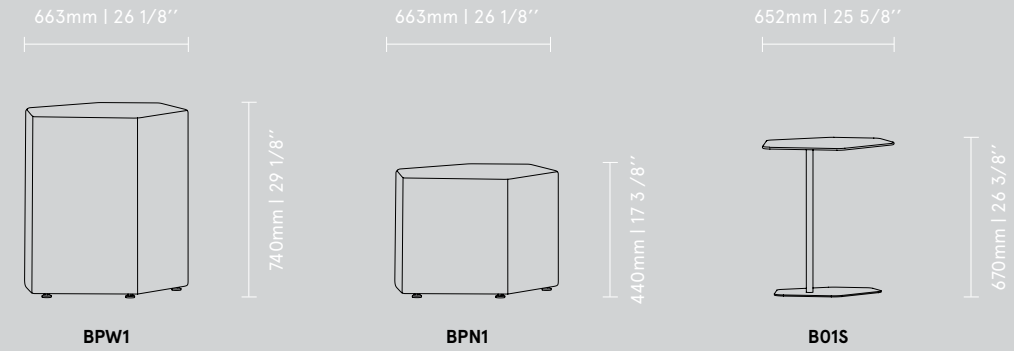



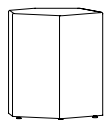

BPW1
663 / 522 / 740
26 1/8" / 20 4/8" / 29 1/8"

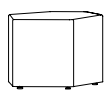

BPN1
663 / 522 / 440
26 1/8" / 20 4/8" / 17 3/8"



BO1S
652 / 505 / 670
25 5/8" / 19 7/8" / 26 3/8"





Shila

by Javier Cuñado

Offering multiple choices, Shila is a chair that adapts to you.

It's a flexible solution provided in a simple form. Inspired by an idea to meet both office and contract market, this collection offers numerous customisation options including a series of bases, optional armrest and seat cushion. Not only does Shila serve as a guest chair, but also can be a bench with comfortable table top.

All that is available in a subdued colour palette that adds style to any space. Designed to create and elaborate "new efficiency" at work, this seating line promotes motivation, collaboration, movement and dynamism.

590mm | 23 2/8"

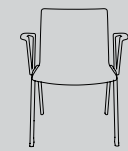
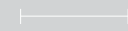

SHILA P base S01 armrest

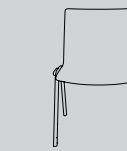

SHILA P base S01

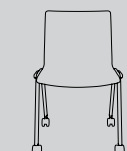

SHILA P base S01K

590mm | 23 2/8"



SHILA P base S01K

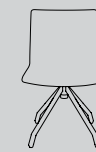

SHILA P base S07



SHILA P base S07K



SHILA P base S10

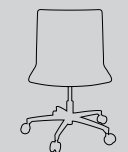

SHILA P base S10K

1625mm | 65"

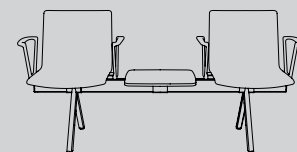

SHILA B

545mm | 21 4/8"







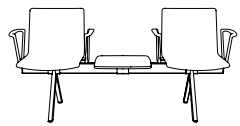

SHILA B
 1625 / 545 / 815
 65" / 21 4/8" / 32 1/8"





SHILA P base S01
590 / 590 / 815
23 2/8" / 23 2/8" / 32 1/8"

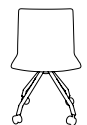

SHILA P base S07K
590 / 590 / 815
23 2/8" / 23 2/8" / 32 1/8"





Kaiva

by Dymitr Malcew

Characteristic form and modular structure – Kaiva is a soft furniture system that allows its users to create their own set.

The line was inspired by an image of stacked stones. According to the concept, various configurations are based on just few elements, that can be freely combined and modified. As its name means conversation in Japanese, Kaiva can serve both as a place of collaborative

work and informal meetings as well as a place of individual focused work. Featuring soft form, touch-friendly fabrics and large colour palette, it introduces positive atmosphere into a workplace. This range can be used in office spaces, hotels, waiting areas and public places.

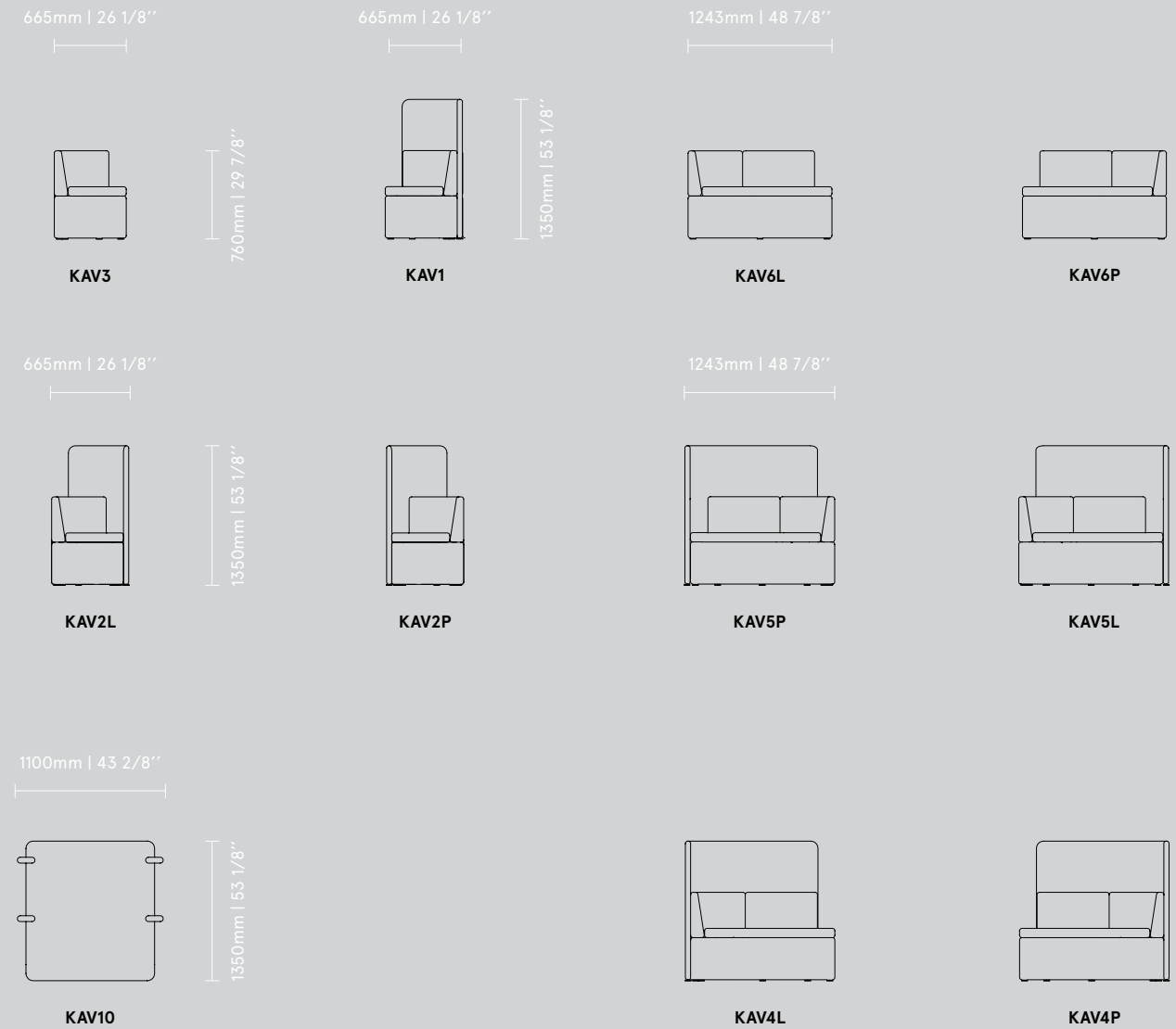

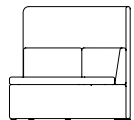

KAV4P
1243 / 665 / 1350
48 7/8" / 26 1/8" / 53 1/8"

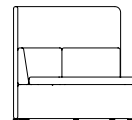

KAV4L
1243 / 665 / 1350
48 7/8" / 26 1/8" / 53 1/8"

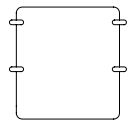

KAV10
1100 / 4 / 1350
43 2/8" / 1/8" / 53 1/8"

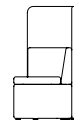

KAV1
665 / 665 / 1350
26 1/8" / 26 1/8" / 53 1/8"



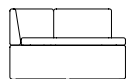

KAV6L
1243 / 665 / 760
48 7/8" / 26 1/8" / 29 7/8"



KAV3
665 / 665 / 760
26 1/8" / 26 1/8" / 29 7/8"





Frank

by Krystian Kowalski

Precision of workmanship and maximum comfort of use – the Frank armchair is created in harmony with ergonomics to bring comforts of home into the workplace.

reception areas. The cushion provided underlines the ergonomics of its design, while tilted seat creates a sense of serenity. Being elegant, it is designed for work as well as relaxation.

The minimalist design provides us with sophistication of large executive armchairs. With two base types to choose from: classic 4-legged or 4-star swivel frame, Frank can be used in a variety of spaces, such as lounge-, team work- or

792mm | 31 1/8"

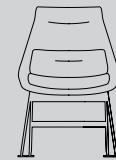

Frank base F01

907mm | 35 6/8"



Frank base F02

749mm | 29 4/8"



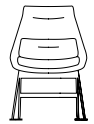

Frank base F01
792 / 749 / 907
31 1/8" / 29 4/8" / 35 6/8"



Frank base F02
792 / 749 / 907
31 1/8" / 29 4/8" / 35 6/8"



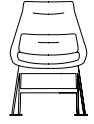

Frank base F01
792 / 749 / 907
31 1/8" / 29 4/8" / 35 6/8"





Sava

design mdd

Personalised comfort for all users in one ergonomic solution – Sava was designed to handle long hours of sitting.

Every part can be tailored to the needs of today's workplace. It supports a great range of postures through

flexible backrest and sliding seat. Height, width and depth adjustable armrests let you rest the arms. Customisation options include curved headrest and movable lumbar support. Breathable mesh on the backrest creates ideal seat comfort. Enabling you to express your company's brand, its finishes offer abundance of choice.

640mm | 25 2/8"



Sava

1145-1335mm | 45 1/8"-52 4/8"

610mm | 24"





Sava
640 / 610 / 1145-1335
25 2/8" / 24" / 45 1/8"-52 4/8"





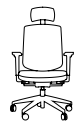

Sava
640 / 610 / 1145-1335
25 2/8" / 24" / 45 1/8"-52 4/8"



Gaya

design mdd

Waiting hall, conference room or open-plan office – Gaya is a multi-purpose chair that perfectly complements every workspace.

Whether four-legged or with cantilever, it's suitable for a wide range of applications. Little storage space is

required as it stacks. Available with either arm or armless designs, Gaya can be customised to perform well in any setting. While the backrest is covered in an airy mesh, the seat can be upholstered with a vast selection of fabrics or made of durable plastic. Four leg base can be provided with castors for mobility.

490mm | 26"

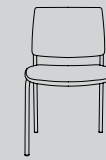

Gaya



515mm | 20 1/8"

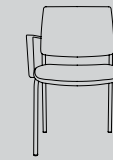

490mm | 26"

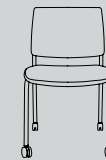

Gaya K



515mm | 20 1/8"



4 pieces max



4 pieces max





Gaya
490 / 515 / 835
26" / 20 1/8" / 32 4/8"





Tanya

design mdd

Spine-friendly shape of the backrest and easy-to-use mechanisms – Tanya delivers performance that meets varied ergonomic requirements.

While adjustable armrests allow your arms to rest comfortably, lumbar support reduces pressure in the

lower back. Synchronous mechanism ensures long-term comfort during work, as the seat tilts when the backrest does. Elastic mesh used on the backrest lets your back breathe. Whether it's personal workstation or home office, its classic design fits into any work environment.

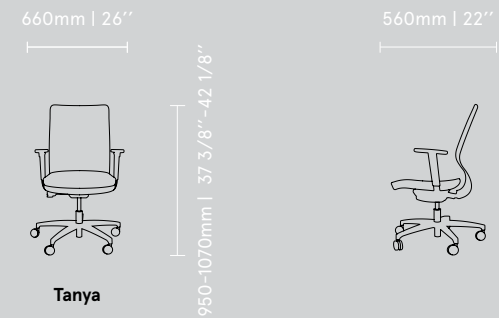





Tanya
 660 / 560 / 950-1070
 26" / 22" / 37 3/8"-42 1/8"



Ayla

design mdd

Simple form combined with mechanisms allowing to adjust a chair to its user – Ayla provides all-day comfort.

The shape of polyurethane and upholstered backrest as well supports the spine's natural curve, reducing the strain on your back. Offering seven levels of backrest

height adjustment, it fits your body even better. Another mechanism used moves backrest and seat at the same time, so that it's easy to change working positions. Thanks to optimal dimensions and universal optic, Ayla works well as an equipment for small home office and as solution for multi-station arrangement.

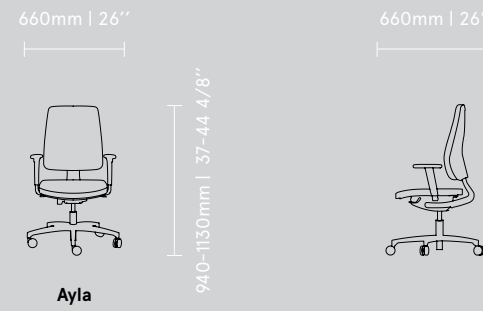





Alya
660 / 660 / 940-1130
26" / 26" / 37-44 4/8"





Ayla
 660 / 660 / 940-1130
 26" / 26" / 37-44 4/8"

Designers



Krystian Kowalski

As a hands-on designer my work process combines a full-scale models and prototypes with technology research and advance cad modelling. This methodical approach is focused on revealing the essence of each design. I believe experiencing the product is the only way to develop valuable furniture. Fundamentally I look at design as an exercise in creating value.



Dymitr Malcew

I'm inspired by things that happen on the periphery and at the intersection of disciplines, cultures and experiences. Regardless of the scale, form or style of the product, designing "experiences" is always the priority. Frame, material and detail is a form of communication with the user.



Form Us With Love

Good design is a hard question—it's in the eye of the beholder. But if you manage to put a material on the right spot, in both an interior or a product, you come quite for.



Andreas Krob

A good office chair should be intuitive in how it's used.



Javier Cuñado

In a smart working environment, each team member should be supported to improve their efficiency.

