

Seating



.mdd

Contents:

Ulti – 3

Ultra – 9

Shila – 15

New School – 23

Afi – 31

Team – 37

Agora – 41

Grace – 47

Grace chair / hoker – 53

Frank / Fat Frank – 61

Kaiva – 67

Roll – 71

Mix – 77

Stilt – 81

Mesh – 87

Shape – 93

Bazalto – 97



Ulti

by Krystian Kowalski

A combination of minimalist design and high comfort – Ulti sets a new standard for conference chairs.

With a wide range of finishes and base options it perfectly adapts to a variety of aesthetics, work styles, and environments — from offices or public utilities to home interiors. Designed to be eye-catching yet functional, the Ulti chair can be provided with castors or glides and

armrests as well. Whether with hard-wearing metal base, or wooden one with homely feel, it ensures long-term comfort.



450 mm | 17 6/8"



UKP1

570 mm | 22 4/8"



UKP7



900 mm | 35 3/8"

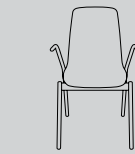

UKP1 with armrests

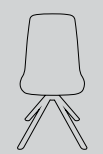

UKP4



UKP3K

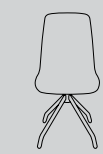

UKP7

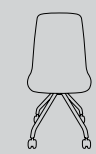

UKP7K

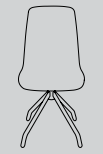

UKP4



UKP4K



UKP5



mdd.eu

Ulti

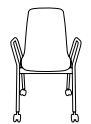

UKP3K
450 / 570 / 900
17 6/8" / 22 4/8" / 35 3/8"



UKP7
450 / 570 / 900
17 6/8" / 22 4/8" / 35 3/8"



UKP1 with armrest
450 / 570 / 900
17 6/8" / 22 4/8" / 35 3/8"



UKP1
450 / 570 / 900
17 6/8" / 22 4/8" / 35 3/8"



UKP7K
450 / 570 / 900
17 6/8" / 22 4/8" / 35 3/8"





Ultra

by Krystian Kowalski

Ergonomically-shaped shell seat and numerous metal and wooden base options – Ultra means many solutions.

The most striking feature of the Ultra armchair forms the cushion fastened to its backrest. Designed not only to catch the eye, it provides comfort needed to make sitting a pleasure. Fusing distinctive design and maximum functionality, the Ultra armchair will fit multitude of

uses around your office or even at home — from formal gatherings in conference room to family meetings in dining area.



600 mm | 23 5/8"



UFP1

600 mm | 23 5/8"



UFP7



850 mm | 33 4/8"



UFP11



UFP11K



UFP9



UFP7

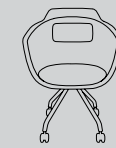

UFP7K

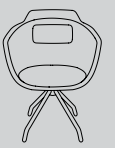

UFP4



UFP4K



UFP5



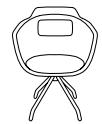

UFP7
600 / 600 / 850
23 5/8" / 23 5/8" / 33 4/8"



UFP1
600 / 600 / 850
23 5/8" / 23 5/8" / 33 4/8"



UFP7K
600 / 600 / 850
23 5/8" / 23 5/8" / 33 4/8"



Shila

by Javier Cuñado

Offering multiple choices, Shila is a chair that adapts to you.

It's a flexible solution provided in a simple form. Inspired by an idea to meet both office and contract market, this collection offers numerous customisation options including a series of bases, optional armrest and seat cushion. Not only does Shila serve as a guest chair, but also can be a bench with comfortable table top.

All that is available in a subdued colour palette that adds style to any space. Designed to create and elaborate "new efficiency" at work, this seating line promotes motivation, collaboration, movement and dynamism.

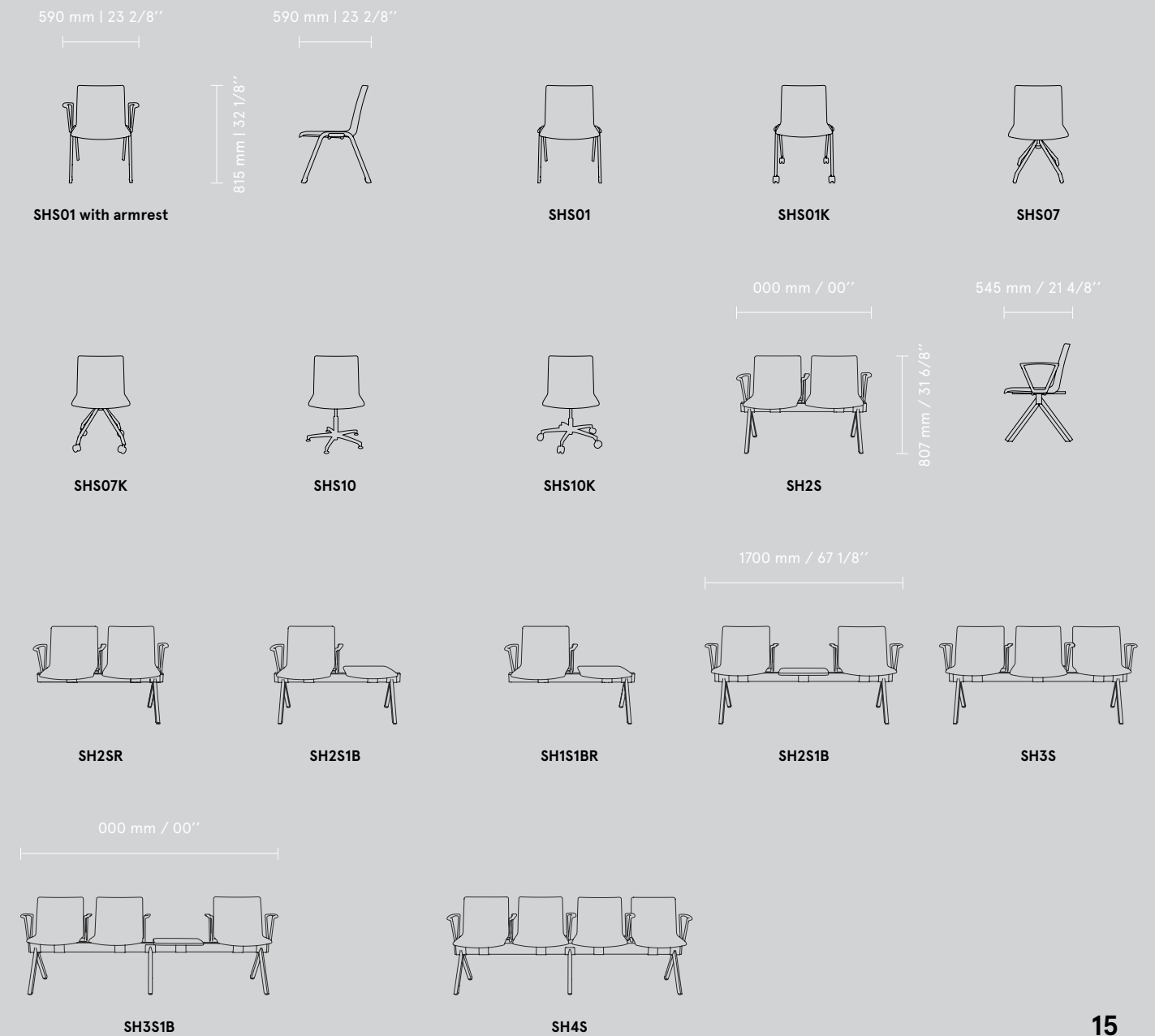



SHS01
590 / 590 / 815
23 2/8" / 23 2/8" / 32 1/8"

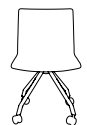

SHS07K
590 / 590 / 815
23 2/8" / 23 2/8" / 32 1/8"





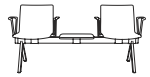

SH2S1B
 1700 / 545 / 807
 67 1/8" / 21 4/8" / 31 6/8"



New School

by Form Us With Love

To create opportunities through small means, it offers a vast number of combinations tailored to the way you want it.

Find possibilities within its humane and simple construction to make a complete range of typologies for the kinds of activities happening today within the many spaces from cafe to home and office. Growing on the classic school chair, New School provides a range

of options available to meet the varied ergonomic requirements of modern office environment – add castors for mobility, headrest for increased comfort or choose an option with armrest to support a range of arm postures.



458 mm | 18"

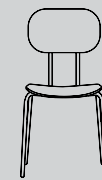

N1N01

817 mm | 32 1/8"

535 mm | 21 1/8"



N1N01 with armrest

817 mm | 32 1/8"

535 mm | 21 1/8"

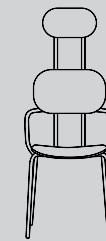

N2N01

11186 mm | 46 6/8"

603 mm | 23 6/8"

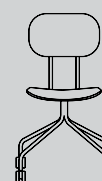

N1N03K



N1N03K with armrest

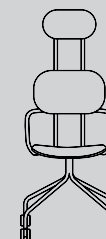

N2N03K

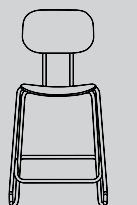

N1N04H

995 mm | 39 1/8"

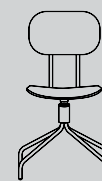

N1N07

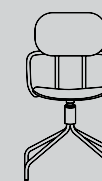

N1N07 with armrest

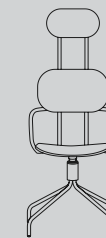

N2N07

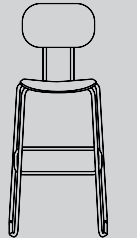

N1N05H

1175 mm | 46 2/8"



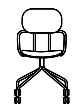

N1N03K with armrest
550 / 550 / 817
21 5/8" / 21 5/8" / 32 1/8"





Afi

by Gudmundur Ludvik

Designed with utmost attention to details and manufactured with the finest craftsmanship – AFI is the ultimate answer to a versatile chair and stool.

Its adaptiveness to the specificity of the surroundings makes it an obvious pick for hotels, medical centres, restaurants, offices, but also residential and public spaces. The backrest was designed with comfort in mind. Embracing the user in a delicate grip, AFI ensures a

stable sitting position. The powder-coated black matte finish of the frame helps AFI seamlessly blend with any interior and emphasises its exquisite shape. Both the seat and the backrest are made of veneer plywood available in two subdued shades of oak. AFI conveys the concept of minimalism supported by the high-quality materials making its affiliation with the Scandinavian design by no means accidental.

567 mm | 22 3/8"



AF04

801 mm | 31 4/8"

530 mm | 20 7/8"



AF01



AF02

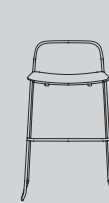

AF06

1000 mm | 39 3/8"



AF07



AF08

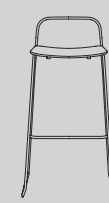

AF01

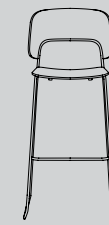

AF02

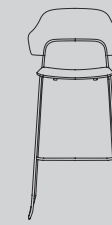

AF03

1068 mm | 43 1/4"





mdd.eu

Afi

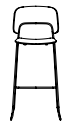

AF02
 567 / 530 / 1098
 22 3/8" / 20 7/8" / 43 1/4"



AF03
 567 / 530 / 1098
 22 3/8" / 20 7/8" / 43 1/4"



AF01
 567 / 530 / 1098
 22 3/8" / 20 7/8" / 43 1/4"



Team

by Dirk Winkel

A versatile collection of furniture for the home, commercial, and office use.

Constituting of a chair and high stool, Team is a range of consistent design and coherent solutions. Dirk Winkel, the designer behind the Team project, was driven by

his passion for geometrical purism. Such an approach allowed him to create a form that immediately adapts to the interior arranged in any given style. .mdd and Dirk Winkel managed to step up the game and find a common language that resulted in the creation of an exceptional collection.

500 mm / 19 5/8"



TE01

569 mm / 22 3/8"

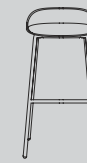

TE01H

934 mm / 36 6/8"

1020 mm / 40 1/8"



TE02

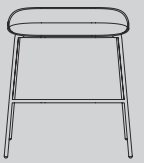

TE02H



mdd

mdd

mdd.eu

Team



TE01
500 / 569
19 5/8" / 22 3/8"



TE01H
500 / 934
19 5/8" / 36 6/8"



Agora

by Form Us With Love

Being comprised of five elements, it can serve as a bench, a shelf, a sofa or a combination of these units at the same time.

With two seat types, table top and three-tiered shelving unit to choose from, Agora embodies flexibility. Built on tubular structure, it can be as long as you need it to be. Combine these square-shaped units and create any sitting area suited

to the character and size of space arranged – from partitioned meeting point to a place to socialise or to welcome visitors. With original meaning of its name in mind, Agora fosters collaborative behaviours.



609 mm | 25" 609 mm | 25"

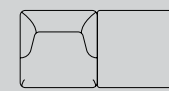

609 mm | 25"

609 mm | 25"



652 mm | 25 5/8"



Bench ES01

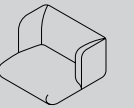

Sofa ES02



Table ES03

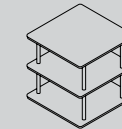

Shelf ES04



AR1K elements to end any configuration

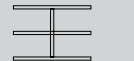

AR1S element to connect separate frame

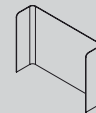

AP01

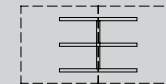

Frame AR01



Frame AR02

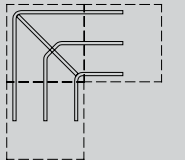

Frame AR03

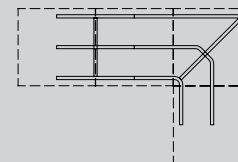

Frame AR04

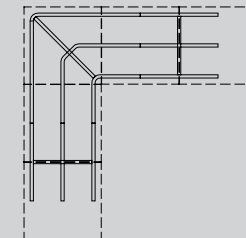

Frame AR05



AR06



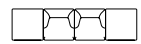

Frame: 2 x AR01 + AR1K + AR1S
Elements: 2 x ES02 + 2 x ES03
 2436 / 609 / 652
 100" / 25" / 25 5/8"



Grace

by Krystian Kowalski

The Grace furniture family includes sofa, armchair and two tables – featuring sleek design and thoughtful proportions, it graces every room.

Thanks to the combination of distinct seat lines and minimalist frame style it gains a sculptural character. Available in a variety of finishes, this line provides a wide spectrum of arrangement possibilities. That's why not only does the Grace sofa work well in a spacious lobby

of skyscrapers but also in a tiny home office. When combined together, sofas and tables create a lounge area infused with a touch of elegance. Thoughtfully chosen seat materials ensure high comfort of use.

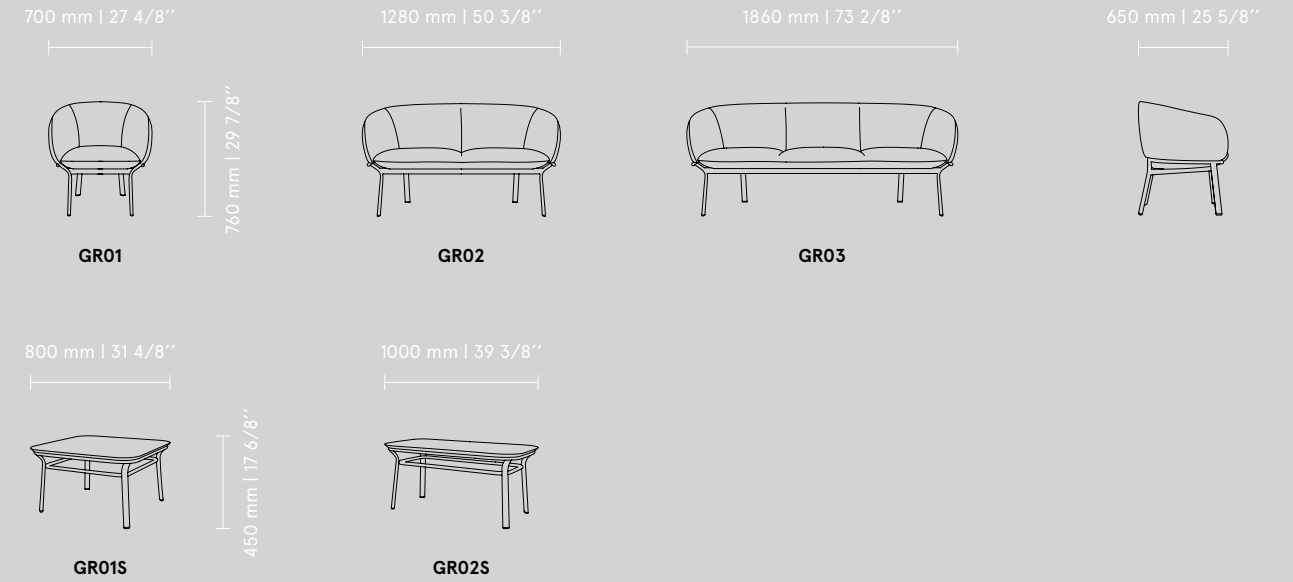

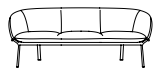

GR03
 1860 / 650 / 760
 73 2/8" / 25 5/8" / 29 7/8"



GR01
 700 / 650 / 760
 27 4/8" / 25 5/8" / 29 7/8"





Grace chair / hoker

by Krystian Kowalski

The chair and stool from the Grace collection is an elegant add-on to the workplace, reception, bar areas, waiting rooms or relaxation zones.

Classic style, distinctive design and a wide range of bases allow creating a chair that will meet the preferences and requirements of the user. The seat with a four-spoke base, available with or without castors, will add an interesting touch to the home office environment while providing maximum comfort of use. The variant with an upholstered leg is an option for less formal zones in the

office whereas the one with the tubular base will perfectly fit in spaces with a loft and industrial character.

Grace stool invites to take a seat for longer. Elegant framework, in two heights, ensures balance and stability, while the abundance of configuration options allows for great adaptability. Grace offers an armchair experience in a high stool edition.

The chair and stool is available in a full range of MDD colours and fabrics.

550 mm | 21 5/8"



GRP5

518 mm | 20 3/8"



GRP5



GRP4K



GRP4

775 mm | 30 4/8"

550 mm | 21 5/8"



GRP6



GRP7

942 mm | 37 1/8"

506 mm | 19 7/8"



550 mm | 21 5/8"

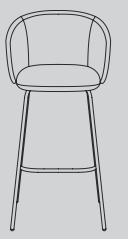

GR08

1102 mm | 43 3/8"







GRP8
550 / 506 / 1102
21 5/8" / 19 7/8" / 43 3/8"





Frank / Fat Frank

by Krystian Kowalski

Precision of workmanship and maximum comfort of use – the Frank armchair is created in harmony with ergonomics to bring comforts of home into the workplace.

reception areas. The cushion provided underlines the ergonomics of its design, while tilted seat creates a sense of serenity. Being elegant, it is designed for work as well as relaxation.

The minimalist design provides us with sophistication of large executive armchairs. With two base types to choose from: classic 4-legged or 4-star swivel frame, Frank can be used in a variety of spaces, such as lounge-, team work- or

792 mm | 31 1/8"

749 mm | 29 4/8"

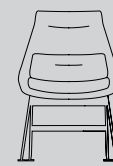

F01

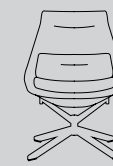

F02



F03

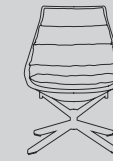

F04

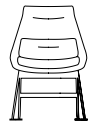

F01
792 / 749 / 907
31 1/8" / 29 4/8" / 35 6/8"



F02
792 / 749 / 907
31 1/8" / 29 4/8" / 35 6/8"





Kaiva

by Dymitr Malcew

Characteristic form and modular structure – Kaiva is a soft furniture system that allows its users to create their own set.

The line was inspired by an image of stacked stones. According to the concept, various configurations are based on just few elements, that can be freely combined and modified. As its name means conversation in Japanese, Kaiva can serve both as a place of collaborative

work and informal meetings as well as a place of individual focused work. Featuring soft form, touch-friendly fabrics and large colour palette, it introduces positive atmosphere into a workplace. This range can be used in office spaces, hotels, waiting areas and public places.





KAV3
665 / 760
26 1/8" / 29 7/8"

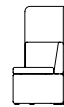

KAV1
665 / 1350
26 1/8" / 53 1/8"

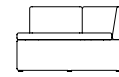

KAV6P
1243 / 760
48 7/8" / 29 7/8"

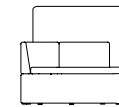

KAV4P
1285 / 1350
50 5/8" / 53 1/8"



Roll

by Beza Projekt

Roll – Be creative the way you like it. Multifunctional seat system Roll is a brand new collection in the .mdd’s offer.

The collection was inspired by the 80s’ style and Italian postmodernism. The furniture system consists of leaning rail, pouffes, sofa, and coffee tables. Modern leaning rails make a great element of public spaces such as gyms, shopping malls, theatres or cinemas but also part of the office and chill-out zones arrangements. Roll leaning rails are available in various dimensions. Among the obtainable modules, there is also a version with a middle partition wall. Pouffes with aluminium bases allow creating diverse layouts with the rest of the collection. They are suitable for both smaller interiors as well as larger open public and office spaces. The offer

also features a Roll sofa constituting of the leaning rail and upholstered soft pouffes. Such a combination of furniture can be later used in lounge zones, which by definition should be a place supporting relaxation and regeneration. By implementing the module with partition wall into the sofa, one can designate separate areas in the space what makes the sofa that much more functional. The coffee tables with their timeless and distinctive design complement the system. Dozens of fabrics to choose from make Roll not only a great element of a modern décor but also a classic one. What is more, the collection shows a multitude of colour options that help to achieve a stylistically coherent arrangement regardless of the leading style of the interior. The space with Roll collection in it will certainly be filled with an inspiring character.

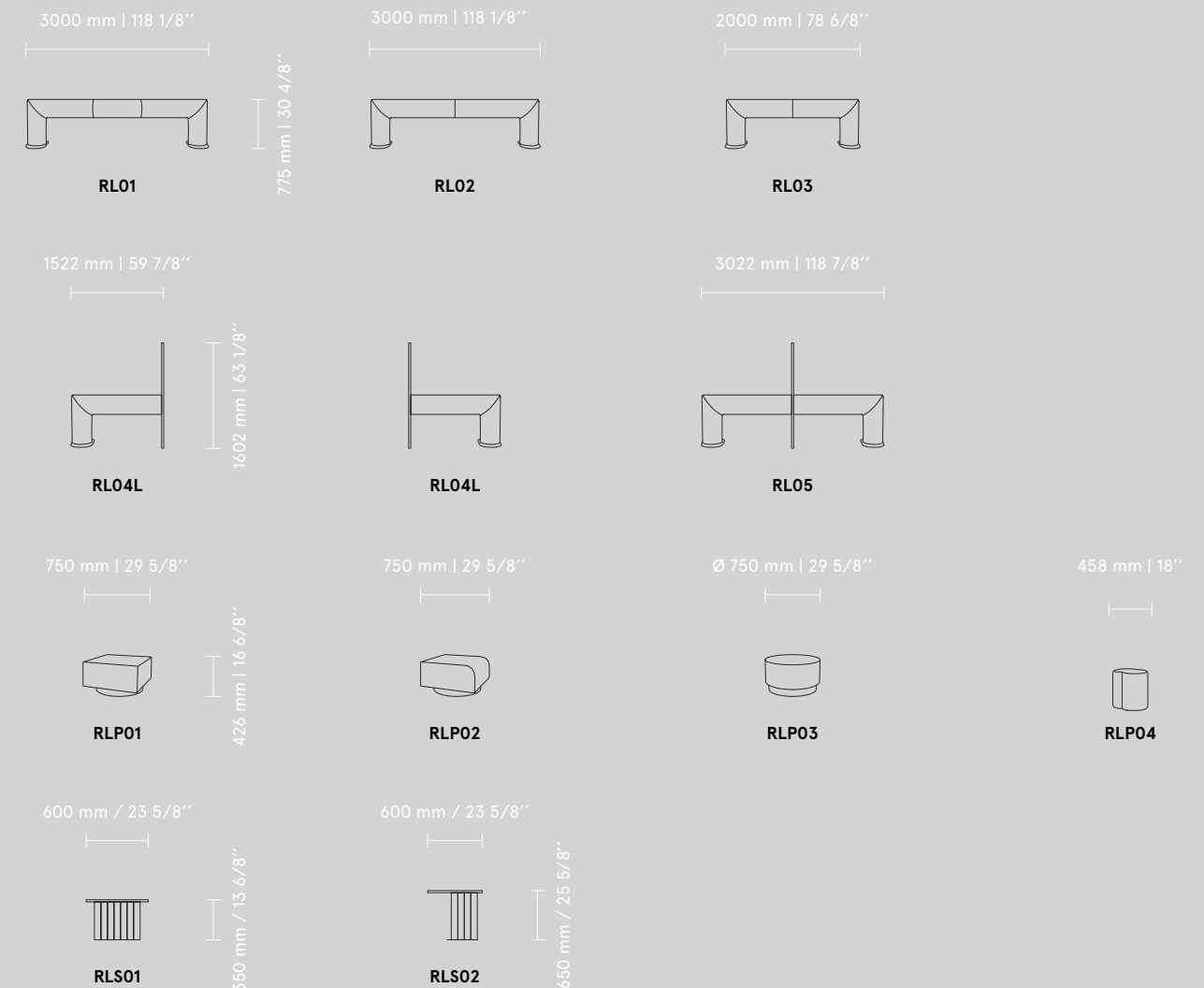



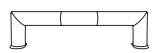

RL01
3000 / 775
118 1/8" / 23 5/8" / 30 4/8"



RLP04
458 / 426
18" / 16 6/8"



RLP02
750 / 426
29 5/8" / 16 6/8"



RLS01
600 / 350
23 5/8" / 13 6/8"



Mix

design mdd

MIX is a pouf system of geometric shapes that encourage creativity while arranging the space.

Soft seating is suitable not only for closed relaxation zones but also for open space offices, waiting rooms, reception areas and even home. Available in many

different colours, they will enliven any space in which they are located. Compact furniture is an interesting and functional addition to a modern office. Optional wheels ensure mobility.

425 mm / 16 6/8"

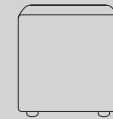

MX01

Ø 457 mm / 18"

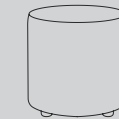

MX02

450 mm / 17 6/8"







Stilt

by Form Us With Love

Form Us With Love inspired by the steel tubing capabilities of the .mdd factory, witnessed during the New School project collaboration, wanted to take it a step further and build a collection using the same language throughout the entire range.

of that goal: a collection of superior adaptability that can be used in a wide range of interiors, from the hospitality industry to offices and homes.

The key idea was to develop seating and shelving systems that can allocate space within an area while still being a comfortable and functional part of it. Stilt is the product

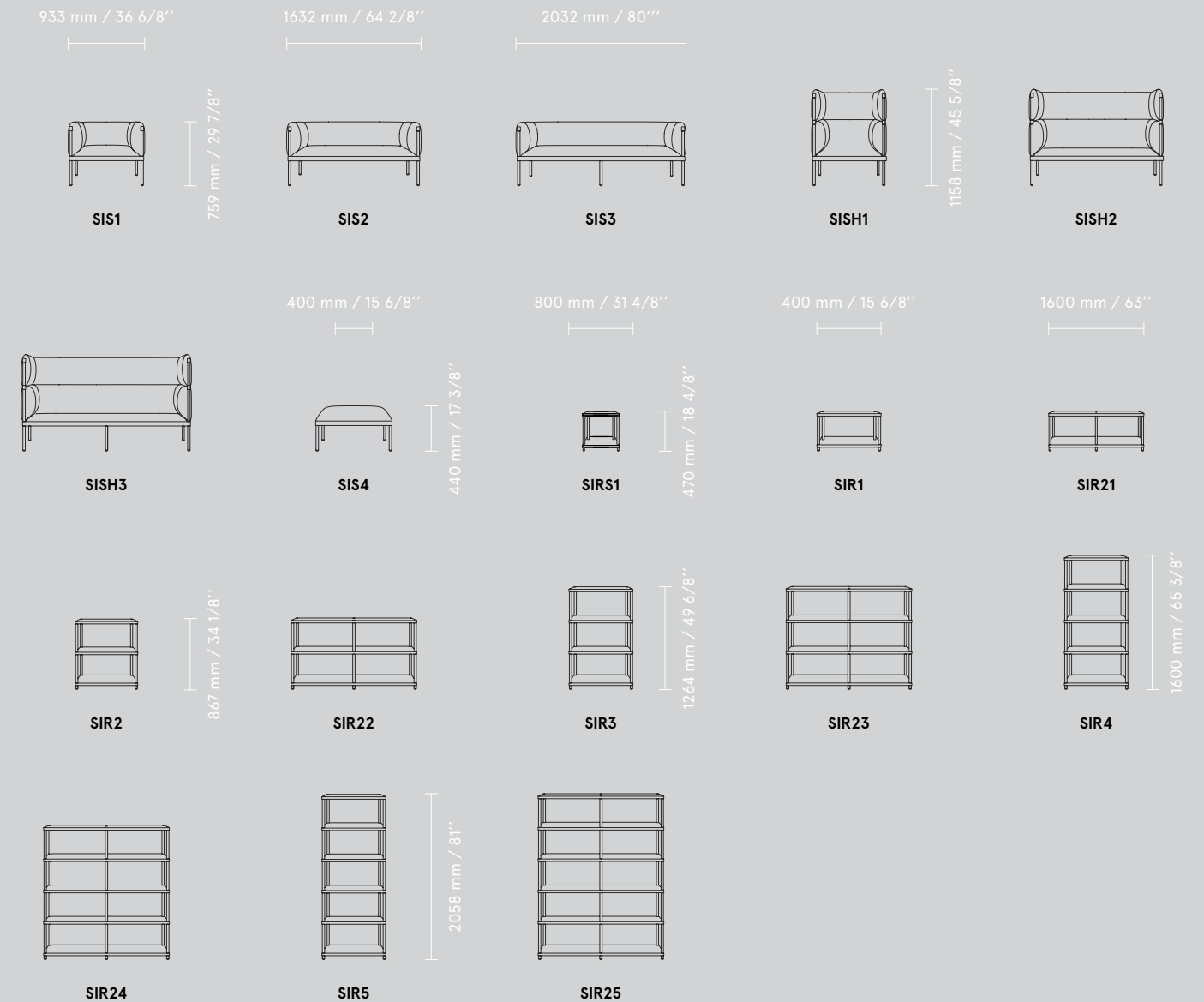

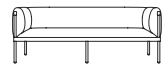

SIS3
2032 / 759
80" / 29 7/8"



SIS1
933 / 759
36 6/8" / 29 7/8"



SIR22
1600 / 867
63" / 34 1/8"





Mesh

by Krystian Kowalski

Designed to create friendly office spaces, it can be easily customised to fit a specific space or need.

The Mesh line offers a sofa, an armchair and two tables that bring comforts of home to the workplace. Thanks to its design, it may serve as a place to relax as well as a piece of decoration, and finally as a functional item. The shield available in three sizes becomes the most striking feature of this range – use it to create a

comfortable oasis or a less informal meeting area. Being more than beautifully crafted seating solution, Mesh combines a tailored, craft-based approach with the precision of high-volume technology.

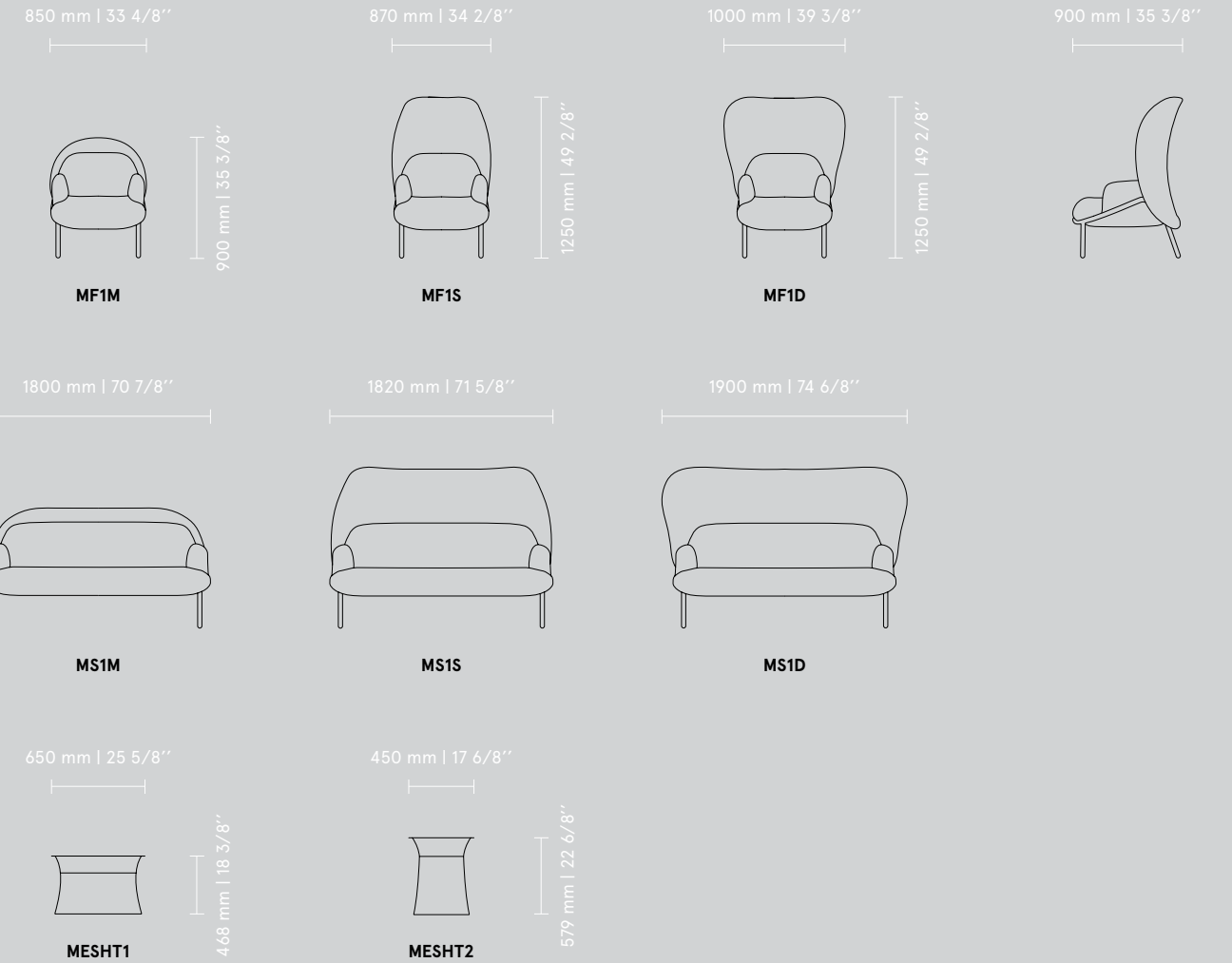



MF1M
850 / 900 / 900
33 4/8" / 35 3/8" / 35 3/8"



MF1D
1000 / 900 / 1250
39 3/8" / 35 3/8" / 49 2/8"

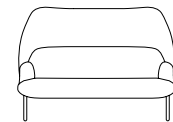

MS1S
1820 / 900 / 1250
71 5/8" / 35 3/8" / 49 2/8"

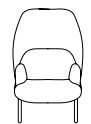

MF1S
870 / 900 / 1250
34 2/8" / 35 3/8" / 49 2/8"

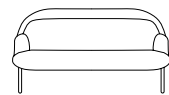

MS1M
1800 / 900 / 900
70 7/8" / 35 3/8" / 35 3/8"

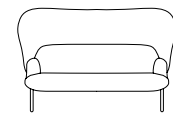

MS1D
1900 / 900 / 1250
74 6/8" / 35 3/8" / 49 2/8"





Shape

Ergonomic and extremely comfortable – Shape collection consists of multi-coloured poufs with backrest thanks to which chill-out zones will gain a completely new quality.

This piece of furniture creates friendly and energetic informal spaces. Appearing in several pieces arrangements or separately, the poufs with backrest are

a perfect addition to waiting rooms, social areas, and offices. Shape's spine-friendly and ergonomic design helps to minimize discomfort. By implementing them to larger spaces, it is possible to designate separate areas of various functionality. The pouf provides functionality whereas its abundant colour range introduces freshness and expressive character to the interior.

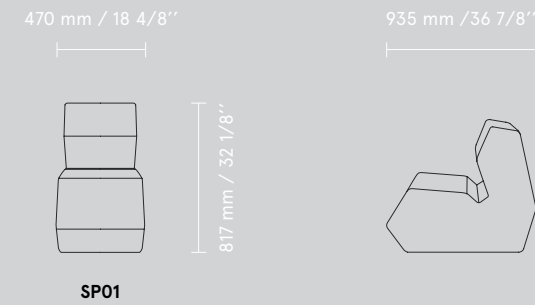

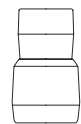

SP01
 47° / 935 / 817
 18 4/8" / 36 7/8" / 32 1/8"



Bazalto

by Andreas Krob

It's a fresh approach to casual seating. The design possibilities are endless and are all up to you.

Inspired by the Giant's Causeway in Northern Ireland, Bazalto is a new, fun and creative way to design a modern seating arrangement for every office space. With a wide array of fabrics in invigorating colours to choose from, it is easy to personalise. Group them to make one large seating piece fostering collaboration or arrange them

separately to create clusters of small units for more privacy. Combine two different heights – the shorter pouf for a seat and the taller one for a backrest – to achieve perfect solution to office seating needs.

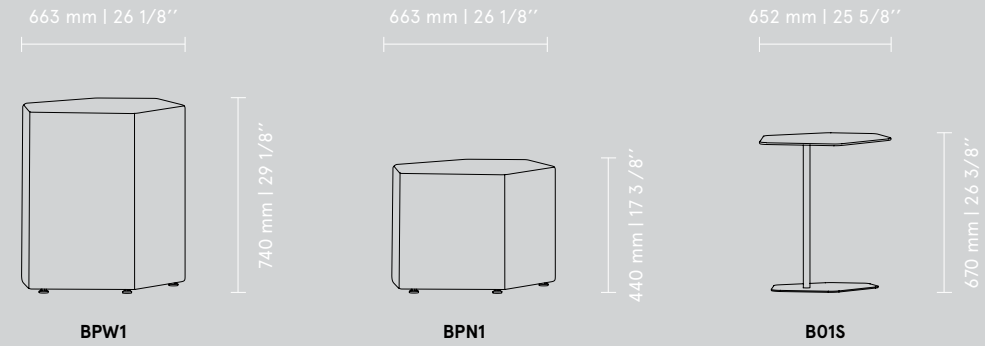



Designers



**Gudmundur
Ludvik**

I am intrigued by the balance between simplicity and complexity. Exploring challenges through multiple perspectives helps me in understanding and reducing them to the core and transforming into simple and intuitive solutions.

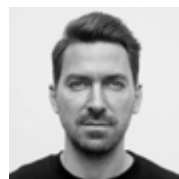

**Dirk
Winkel**

I love exploring new materials and production processes, and I am driven by belief in the beauty of a deeply geometrical formal purism. Careful consideration of every single radius, dimension and proportion of a design is the key to a sustainable formal expression.



**Form Us
With Love**

Good design is a hard question—it's in the eye of the beholder. But if you manage to put a material on the right spot, in both an interior or a product, you come quite for.



**Krystian
Kowalski**

As a hands-on designer my work process combines a full-scale models and prototypes with technology research and advance cad modelling. This methodical approach is focused on revealing the essence of each design. I believe experiencing the product is the only way to develop valuable furniture.



**Javier
Cuñado**

In a smart working environment, each team member should be supported to improve their efficiency.



**Beza
Projekt**

We cross the border between the world of utility items and the world of conceptual artefacts. Each project is based on the individual approach to the client's needs and tells a different story.



**Andreas
Krob**

A good office chair should be intuitive in how it's used.



**Dymitr
Malcew**

I'm inspired by things that happen on the periphery and at the intersection of disciplines, cultures and experiences. Regardless of the scale, form or style of the product, designing "experiences" is always the priority. Frame, material and detail is a form of communication with the user.

